

PHILIPPINE BIDDING DOCUMENTS

PROCUREMENT OF SCHOOL FURNITURE UNDER THE CY 2022 BEFF SCHOOL FURNITURE PROGRAM



Government of the Republic of the Philippines

**Sixth Edition
July 2020**

Preface

These Philippine Bidding Documents (PBDs) for the procurement of Goods through Competitive Bidding have been prepared by the Government of the Philippines for use by any branch, constitutional commission or office, agency, department, bureau, office, or instrumentality of the Government of the Philippines, National Government Agencies, including Government-Owned and/or Controlled Corporations, Government Financing Institutions, State Universities and Colleges, and Local Government Unit. The procedures and practices presented in this document have been developed through broad experience, and are for mandatory use in projects that are financed in whole or in part by the Government of the Philippines or any foreign government/foreign or international financing institution in accordance with the provisions of the 2016 revised Implementing Rules and Regulations of Republic Act No. 9184.

The Bidding Documents shall clearly and adequately define, among others: (i) the objectives, scope, and expected outputs and/or results of the proposed contract or Framework Agreement, as the case may be; (ii) the eligibility requirements of Bidders; (iii) the expected contract or Framework Agreement duration, the estimated quantity in the case of procurement of goods, delivery schedule and/or time frame; and (iv) the obligations, duties, and/or functions of the winning bidder.

Care should be taken to check the relevance of the provisions of the PBDs against the requirements of the specific Goods to be procured. If duplication of a subject is inevitable in other sections of the document prepared by the Procuring Entity, care must be exercised to avoid contradictions between clauses dealing with the same matter.

Moreover, each section is prepared with notes intended only as information for the Procuring Entity or the person drafting the Bidding Documents. They shall not be included in the final documents. The following general directions should be observed when using the documents:

- a. All the documents listed in the Table of Contents are normally required for the procurement of Goods. However, they should be adapted as necessary to the circumstances of the particular Procurement Project.
- b. Specific details, such as the “*name of the Procuring Entity*” and “*address for bid submission*,” should be furnished in the Instructions to Bidders, Bid Data Sheet, and Special Conditions of Contract. The final documents should contain neither blank spaces nor options.
- c. This Preface and the footnotes or notes in italics included in the Invitation to Bid, Bid Data Sheet, General Conditions of Contract, Special Conditions of Contract, Schedule of Requirements, and Specifications are not part of the text of the final document, although they contain instructions that the Procuring Entity should strictly follow.

- d. The cover should be modified as required to identify the Bidding Documents as to the Procurement Project, Project Identification Number, and Procuring Entity, in addition to the date of issue.
- e. Modifications for specific Procurement Project details should be provided in the Special Conditions of Contract as amendments to the Conditions of Contract. For easy completion, whenever reference has to be made to specific clauses in the Bid Data Sheet or Special Conditions of Contract, these terms shall be printed in bold typeface on Sections I (Instructions to Bidders) and III (General Conditions of Contract), respectively.
- f. For guidelines on the use of Bidding Forms and the procurement of Foreign-Assisted Projects, these will be covered by a separate issuance of the Government Procurement Policy Board.

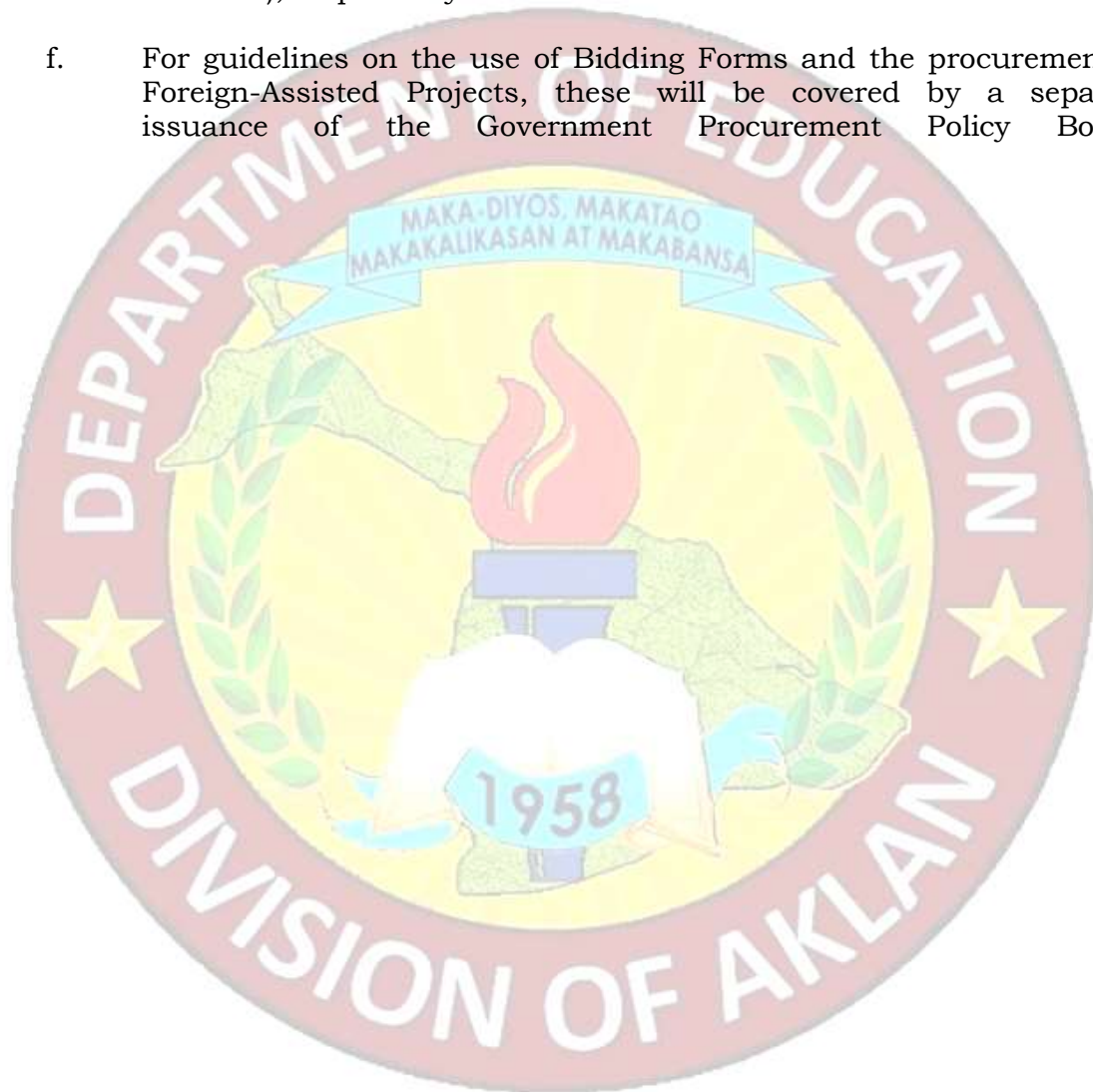

Table of Contents

| | |
|---|-----------|
| Glossary of Acronyms, Terms, and Abbreviations | 4 |
| Section I. Invitation to Bid..... | 7 |
| Section II. Instructions to Bidders..... | 10 |
| 1. Scope of Bid | 11 |
| 2. Funding Information..... | 11 |
| 3. Bidding Requirements | 11 |
| 4. Corrupt, Fraudulent, Collusive, and Coercive Practices | 11 |
| 5. Eligible Bidders..... | 11 |
| 6. Origin of Goods | 12 |
| 7. Subcontracts | 12 |
| 8. Pre-Bid Conference | 12 |
| 9. Clarification and Amendment of Bidding Documents | 12 |
| 10. Documents comprising the Bid: Eligibility and Technical Components | 12 |
| 11. Documents comprising the Bid: Financial Component | 13 |
| 12. Bid Prices | 13 |
| 13. Bid and Payment Currencies | 13 |
| 14. Bid Security | 13 |
| 15. Sealing and Marking of Bids | 13 |
| 16. Deadline for Submission of Bids | 14 |
| 17. Opening and Preliminary Examination of Bids | 14 |
| 18. Domestic Preference | 14 |
| 19. Detailed Evaluation and Comparison of Bids | 14 |
| 20. Post-Qualification | 15 |
| 21. Signing of the Contract | 15 |
| Section III. Bid Data Sheet | 16 |
| Section IV. General Conditions of Contract | 20 |
| 1. Scope of Contract | 21 |
| 2. Advance Payment and Terms of Payment | 21 |
| 3. Performance Security | 21 |
| 4. Inspection and Tests | 21 |
| 5. Warranty | 22 |
| 6. Liability of the Supplier | 22 |
| Section V. Special Conditions of Contract | 23 |
| Section VI. Schedule of Requirements | 28 |
| Section VII. Technical Specifications | 29 |
| Section VIII. Checklist of Technical and Financial Documents | 32 |

Glossary of Acronyms, Terms, and Abbreviations

ABC – Approved Budget for the Contract.

BAC – Bids and Awards Committee.

Bid – A signed offer or proposal to undertake a contract submitted by a bidder in response to and in consonance with the requirements of the bidding documents. Also referred to as *Proposal* and *Tender*. (2016 revised IRR, Section 5[c])

Bidder – Refers to a contractor, manufacturer, supplier, distributor and/or consultant who submits a bid in response to the requirements of the Bidding Documents. (2016 revised IRR, Section 5[d])

Bidding Documents – The documents issued by the Procuring Entity as the bases for bids, furnishing all information necessary for a prospective bidder to prepare a bid for the Goods, Infrastructure Projects, and/or Consulting Services required by the Procuring Entity. (2016 revised IRR, Section 5[e])

BIR – Bureau of Internal Revenue.

BSP – Bangko Sentral ng Pilipinas.

Consulting Services – Refer to services for Infrastructure Projects and other types of projects or activities of the GOP requiring adequate external technical and professional expertise that are beyond the capability and/or capacity of the GOP to undertake such as, but not limited to: (i) advisory and review services; (ii) pre-investment or feasibility studies; (iii) design; (iv) construction supervision; (v) management and related services; and (vi) other technical services or special studies. (2016 revised IRR, Section 5[i])

CDA - Cooperative Development Authority.

Contract – Refers to the agreement entered into between the Procuring Entity and the Supplier or Manufacturer or Distributor or Service Provider for procurement of Goods and Services; Contractor for Procurement of Infrastructure Projects; or Consultant or Consulting Firm for Procurement of Consulting Services; as the case may be, as recorded in the Contract Form signed by the parties, including all attachments and appendices thereto and all documents incorporated by reference therein.

CIF – Cost Insurance and Freight.

CIP – Carriage and Insurance Paid.

CPI – Consumer Price Index.

DDP – Refers to the quoted price of the Goods, which means “delivered duty paid.”

DTI – Department of Trade and Industry.

EXW – Ex works.

FCA – “Free Carrier” shipping point.

FOB – “Free on Board” shipping point.

Foreign-funded Procurement or Foreign-Assisted Project– Refers to procurement whose funding source is from a foreign government, foreign or international financing institution as specified in the Treaty or International or Executive Agreement. (2016 revised IRR, Section 5[b]).

Framework Agreement – Refers to a written agreement between a procuring entity and a supplier or service provider that identifies the terms and conditions, under which specific purchases, otherwise known as “Call-Offs,” are made for the duration of the agreement. It is in the nature of an option contract between the procuring entity and the bidder(s) granting the procuring entity the option to either place an order for any of the goods or services identified in the Framework Agreement List or not buy at all, within a minimum period of one (1) year to a maximum period of three (3) years. (GPPB Resolution No. 27-2019)

GFI – Government Financial Institution.

GOCC – Government-owned and/or –controlled corporation.

Goods – Refer to all items, supplies, materials and general support services, except Consulting Services and Infrastructure Projects, which may be needed in the transaction of public businesses or in the pursuit of any government undertaking, project or activity, whether in the nature of equipment, furniture, stationery, materials for construction, or personal property of any kind, including non-personal or contractual services such as the repair and maintenance of equipment and furniture, as well as trucking, hauling, janitorial, security, and related or analogous services, as well as procurement of materials and supplies provided by the Procuring Entity for such services. The term “related” or “analogous services” shall include, but is not limited to, lease or purchase of office space, media advertisements, health maintenance services, and other services essential to the operation of the Procuring Entity. (2016 revised IRR, Section 5[r])

GOP – Government of the Philippines.

GPPB – Government Procurement Policy Board.

INCOTERMS – International Commercial Terms.

Infrastructure Projects – Include the construction, improvement, rehabilitation, demolition, repair, restoration or maintenance of roads and bridges, railways, airports, seaports, communication facilities, civil works components of information technology projects, irrigation, flood control and drainage, water supply, sanitation, sewerage and solid waste management systems, shore protection, energy/power and electrification facilities, national buildings, school buildings, hospital buildings, and other related construction projects of the government. Also referred to as *civil works or works*. (2016 revised IRR, Section 5[u])

LGUs – Local Government Units.

NFCC – Net Financial Contracting Capacity.

NGA – National Government Agency.

PhilGEPS - Philippine Government Electronic Procurement System.

Procurement Project – refers to a specific or identified procurement covering goods, infrastructure project or consulting services. A Procurement Project shall be described, detailed, and scheduled in the Project Procurement Management Plan prepared by the agency which shall be consolidated in the procuring entity's Annual Procurement Plan. (GPPB Circular No. 06-2019 dated 17 July 2019)

PSA – Philippine Statistics Authority.

SEC – Securities and Exchange Commission.

SLCC – Single Largest Completed Contract.

Supplier – refers to a citizen, or any corporate body or commercial company duly organized and registered under the laws where it is established, habitually established in business and engaged in the manufacture or sale of the merchandise or performance of the general services covered by his bid. (Item 3.8 of GPPB Resolution No. 13-2019, dated 23 May 2019). Supplier as used in these Bidding Documents may likewise refer to a distributor, manufacturer, contractor, or consultant.

UN – United Nations.

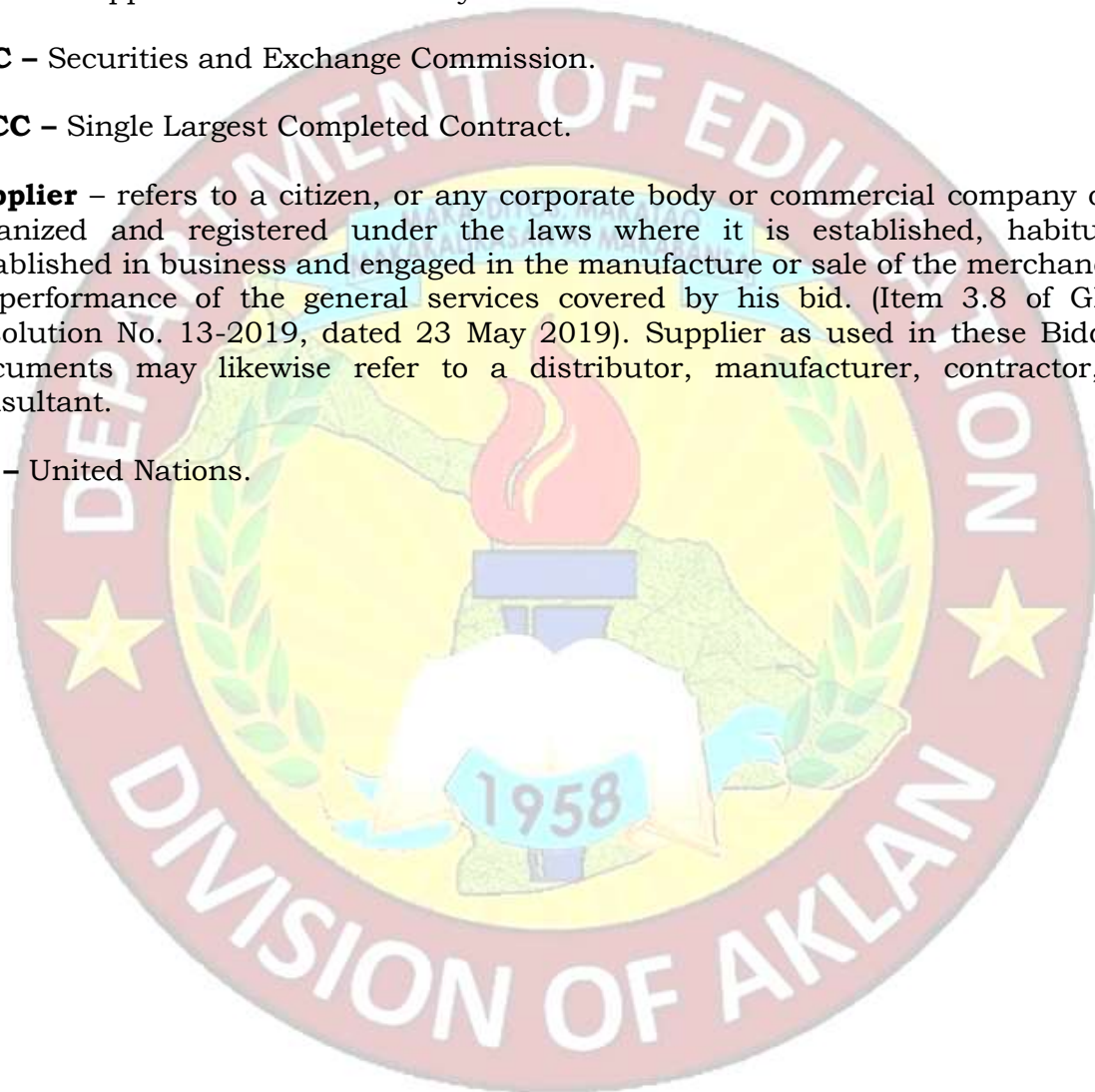

Section I. Invitation to Bid

Notes on the Invitation to Bid

The Invitation to Bid (IB) provides information that enables potential Bidders to decide whether to participate in the procurement at hand. The IB shall be posted in accordance with Section 21.2 of the 2016 revised IRR of RA No. 9184.

Apart from the essential items listed in the Bidding Documents, the IB should also indicate the following:

- a. The date of availability of the Bidding Documents, which shall be from the time the IB is first advertised/posted until the deadline for the submission and receipt of bids;
- b. The place where the Bidding Documents may be acquired or the website where it may be downloaded;
- c. The deadline for the submission and receipt of bids; and
- d. Any important bid evaluation criteria (*e.g.*, the application of a margin of preference in bid evaluation).

The IB should be incorporated in the Bidding Documents. The information contained in the IB must conform to the Bidding Documents and in particular to the relevant information in the Bid Data Sheet.



Republic of the Philippines
 Department of Education
 Region VI – Western Visayas
DIVISION OF AKLAN
 Poblacion, Numancia, Aklan



INVITATION TO BID FOR PROCUREMENT OF SCHOOL FURNITURE UNDER THE CY 2022 BEFF SCHOOL FURNITURE PROGRAM

Project No.: [DepED-RO6-D1-2022SCHOOLFURNITURE-011-2022](#)

The Department of Education Schools Division of Aklan, through the Bids and Awards Committee (BAC) intends to apply the total sum of **Nine Hundred Eighty-Nine Thousand Seven Hundred Thirty Pesos only (Php989,730.00)** being the ABC to payments under the contract for the **Procurement of School Furniture under the CY 2022 BEFF School Furniture Program** in a per lot basis. Bids received in excess of the ABC for each lot shall be automatically rejected at bid opening.

| Lot | Unit | Recipient School | Quantity | Item | Amount | Delivery Period |
|-----------------------------|------|----------------------------------|------------|--------------------------------------|---------------|-----------------|
| 1 | Set | Lezo IS, Lezo, Aklan | 180 | Individual Learner Table & Chair Set | Php565,560.00 | 60 CD |
| | | | 4 | Teacher's Table & Chair Set | | |
| | | Jawili IS, Tangalan, Aklan | 135 | Individual Learner Table & Chair Set | Php424,170.00 | |
| | | | 3 | Teacher's Table & Chair Set | | |
| Total: Php989,730.00 | | | | | | |

1. The Department of Education Schools Division of Aklan through its Bids and Awards Committee (BAC) now invites bids for the above-mentioned Procurement Project. Delivery of the Goods is required by **forty five (45) calendar days**. Bidders should have completed, within three (3) years from the date of submission and receipt of bids, a contract similar to the Project. The description of an eligible bidder is contained in the Bidding Documents, particularly, in Section II (Instructions to Bidders).
2. Bidding will be conducted through open competitive bidding procedures using a non-discretionary “*pass/fail*” criterion as specified in the 2016 revised Implementing Rules and Regulations (IRR) of Republic Act (RA) No. 9184.
 - a. Bidding is restricted to Filipino citizens/sole proprietorships, partnerships, or organizations with at least sixty percent (60%) interest or outstanding capital stock belonging to citizens of the Philippines, and to citizens or organizations of a country the laws or regulations of which

grant similar rights or privileges to Filipino citizens, pursuant to RA No. 5183.

3. Prospective Bidders may obtain further information from Department of Education Schools Division of Aklan – Bids and Awards Committee and inspect the Bidding Documents at the address given below, **from Monday to Friday, 8:00 A.M to 5:00 PM.**
4. A complete set of Bidding Documents may be acquired by interested Bidders on **March 8, 2022 to March 28, 2022** from the given address and website(s) below. Bidding Documents may be obtained in the amount of **One Thousand Pesos only (Php1,000.00).**

The Procuring Entity shall allow the bidder to present its proof of payment for the fees in person.

5. The Department of Education Schools Division of Aklan will hold a **Pre-Bid Conference on March 15, 2022, 9:00 A.M. at Kalibo Pilot Elementary School, Poblacion, Kalibo, Aklan** which shall be open to prospective bidders.
6. Bids must be duly received by the BAC Secretariat **through manual submission at the office address indicated below on or before March 28, 2022, 9:00 A.M. Online or electronic submission is not allowed. Late bids shall not be accepted.**
7. All Bids must be accompanied by a bid security in any of the acceptable forms and in the amount stated in **ITB Clause 14.**
8. **Opening of Bids shall be on March 28, 2022, 9:00 A.M. at Kalibo Pilot Elementary School, Poblacion, Kalibo, Aklan.** Bids will be opened in the presence of the bidders' representatives who choose to attend the activity.
9. The Department of Education Schools Division of Aklan reserves the right to reject any and all bids, declare a failure of bidding, or not award the contract at any time prior to contract award in accordance with Sections 35.6 and 41 of the 2016 revised IRR of RA No. 9184, without thereby incurring any liability to the affected bidder or bidders.
10. For further information, please refer to:
EDSELYN T. BIRAY
Secretariat
Bids and Awards Committee (BAC)
Department of Education, Division of Aklan
Poblacion, Numancia, Aklan
Telephone No. (036) 265-3744 local 109
11. You may visit the following website:
For downloading of Bidding Documents: **depedaklan.online**

JERSON B. LABOS EdD
BAC Chairperson

Section II. Instructions to Bidders

Notes on the Instructions to Bidders

This Section on the Instruction to Bidders (ITB) provides the information necessary for bidders to prepare responsive bids, in accordance with the requirements of the Procuring Entity. It also provides information on bid submission, eligibility check, opening and evaluation of bids, post-qualification, and on the award of contract.

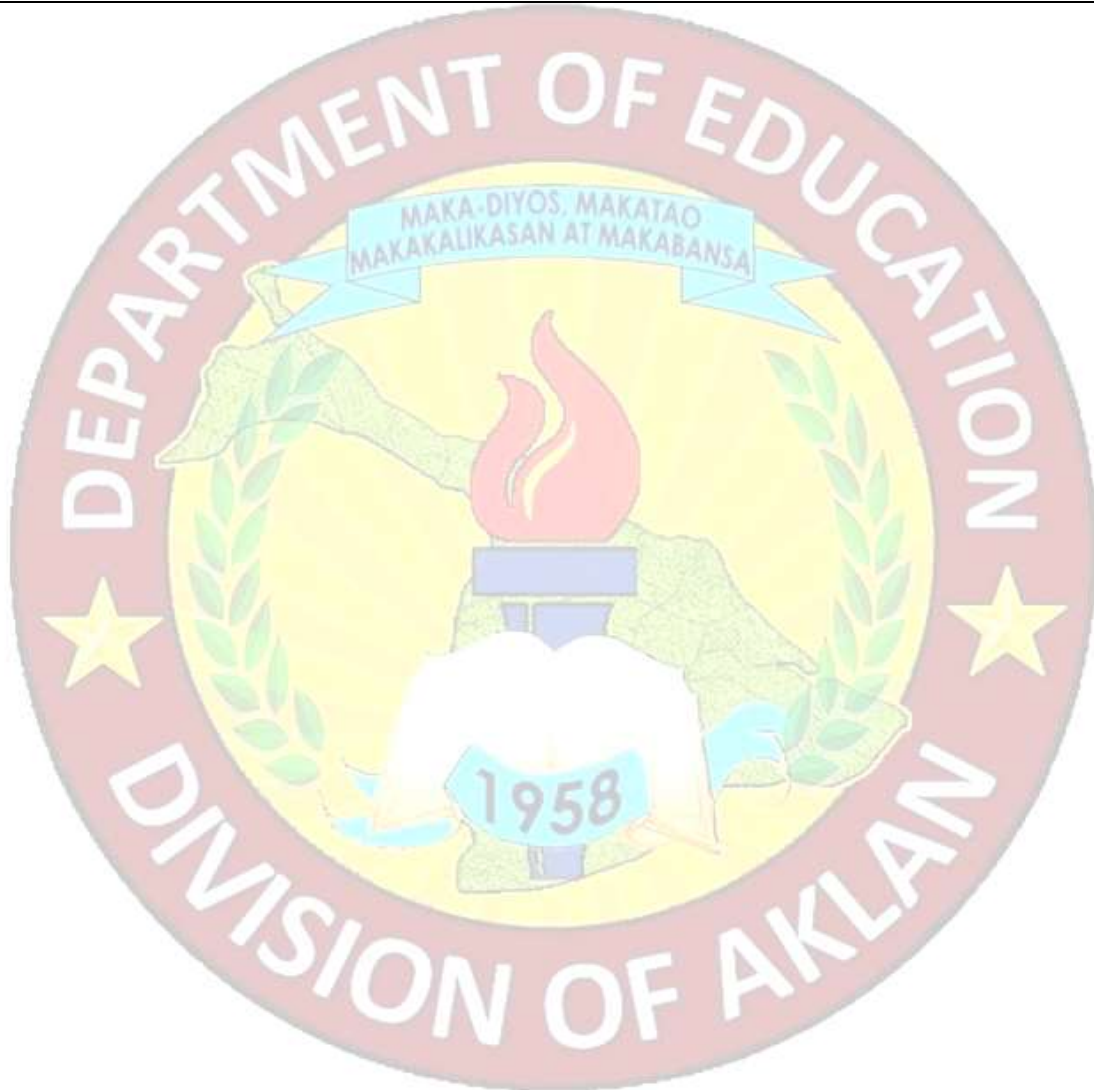

1. Scope of Bid

The Procuring Entity, Department of Education Division of Aklan wishes to receive Bids for the Supply and Delivery of Office and IT Supplies for FY 2020 with identification numbers, [DepED-RO6-D1-2022SCHOOLFURNITURE-011-2022](#).

The Procurement Project (referred to herein as "Project") is composed of **two (2) lots**, the details of which are described in Section VII (Technical Specifications).

2. Funding Information

2.1. The GOP through the source of funding as indicated below for **FY 2022** in the amount of **Nine Hundred Eighty-Nine Thousand Seven Hundred Thirty Pesos only (Php989,730.00)**.

2.2. The source of funding is:

a. **NGA, the General Appropriations Act or Special Appropriations.**

3. Bidding Requirements

The Bidding for the Project shall be governed by all the provisions of RA No. 9184 and its 2016 revised IRR, including its Generic Procurement Manuals and associated policies, rules and regulations as the primary source thereof, while the herein clauses shall serve as the secondary source thereof.

Any amendments made to the IRR and other GPPB issuances shall be applicable only to the ongoing posting, advertisement, or **IB** by the BAC through the issuance of a supplemental or bid bulletin.

The Bidder, by the act of submitting its Bid, shall be deemed to have verified and accepted the general requirements of this Project, including other factors that may affect the cost, duration and execution or implementation of the contract, project, or work and examine all instructions, forms, terms, and project requirements in the Bidding Documents.

4. Corrupt, Fraudulent, Collusive, and Coercive Practices

The Procuring Entity, as well as the Bidders and Suppliers, shall observe the highest standard of ethics during the procurement and execution of the contract. They or through an agent shall not engage in corrupt, fraudulent, collusive, coercive, and obstructive practices defined under Annex "I" of the 2016 revised IRR of RA No. 9184 or other integrity violations in competing for the Project.

5. Eligible Bidders

5.1. Only Bids of Bidders found to be legally, technically, and financially capable will be evaluated.

5.3. Pursuant to Section 23.4.1.3 of the 2016 revised IRR of RA No.9184, the Bidder shall have an SLCC that is at least one (1) contract similar

to the Project the value of which, adjusted to current prices using the PSA's CPI, must be at least equivalent to:

- a. For the procurement of Non-expendable Supplies and Services: The Bidder must have completed a single contract that is similar to this Project, equivalent to at least fifty percent (50%) of the ABC.
- b. For the procurement of Expendable Supplies: The Bidder must have completed a single contract that is similar to this Project, equivalent to at least twenty-five percent (25%) of the ABC.

5.4. The Bidders shall comply with the eligibility criteria under Section 23.4.1 of the 2016 IRR of RA No. 9184.

6. Origin of Goods

There is no restriction on the origin of goods other than those prohibited by a decision of the UN Security Council taken under Chapter VII of the Charter of the UN, subject to Domestic Preference requirements under **ITB** Clause 18.

7. Subcontracts

7.1. The Bidder may subcontract portions of the Project to the extent allowed by the Procuring Entity as stated herein, but in no case more than twenty percent (20%) of the Project.

The Procuring Entity has prescribed that:

- a. Subcontracting is not allowed.

8. Pre-Bid Conference

The Procuring Entity will hold a pre-bid conference for this Project on the specified date and time and either at its physical address as indicated in paragraph 6 of the **IB**.

9. Clarification and Amendment of Bidding Documents

Prospective bidders may request for clarification on and/or interpretation of any part of the Bidding Documents. Such requests must be in writing and received by the Procuring Entity, either at its given address or through electronic mail indicated in the **IB**, at least ten (10) calendar days before the deadline set for the submission and receipt of Bids.

10. Documents comprising the Bid: Eligibility and Technical Components

10.1. The first envelope shall contain the eligibility and technical documents of the Bid as specified in **Section VIII (Checklist of Technical and Financial Documents)**.

- 10.2. The Bidder's SLCC as indicated in **ITB** Clause 5.3 should have been completed within three (3) years prior to the deadline for the submission and receipt of bids.

11. Documents comprising the Bid: Financial Component

- 11.1. The second bid envelope shall contain the financial documents for the Bid as specified in **Section VIII (Checklist of Technical and Financial Documents)**.
- 11.2. If the Bidder claims preference as a Domestic Bidder or Domestic Entity, a certification issued by DTI shall be provided by the Bidder in accordance with Section 43.1.3 of the 2016 revised IRR of RA No. 9184.
- 11.3. Any bid exceeding the ABC indicated in paragraph 1 of the **IB** shall not be accepted.

12. Bid Prices

- 12.1. Prices indicated on the Price Schedule shall be entered separately in the following manner:
- a. For Goods offered from within the Procuring Entity's country:
 - i. The price of the Goods quoted EXW (ex-works, ex-factory, ex-warehouse, ex-showroom, or off-the-shelf, as applicable);
 - ii. The cost of all customs duties and sales and other taxes already paid or payable;
 - iii. The cost of transportation, insurance, and other costs incidental to delivery of the Goods to their final destination; and
 - iv. The price of other (incidental) services, if any, listed in e.

13. Bid and Payment Currencies

- 13.1. Payment of the contract price shall be made in:
- a. Philippine Pesos.

14. Bid Security

- a. The Bidder shall submit a Bid Securing Declaration or any form of Bid Security in the amount indicated in the **BDS**, which shall be not less than the percentage of the ABC in accordance with the schedule in the **BDS**.
- b. The Bid and bid security shall be valid until *120 Calendar Days*. Any Bid not accompanied by an acceptable bid security shall be rejected by the Procuring Entity as non-responsive.

15. Sealing and Marking of Bids

Each Bidder shall submit one copy of the first and second components of its Bid.

The Procuring Entity requests the submission of original copy of the First and Second Components and two (2) additional copies in separate envelopes. However, failure of the Bidders to comply with the said request shall not be a ground for disqualification.

The bidders are requested to provide a Table of Contents and corresponding tab/label for each submitted technical and financial components to help ensure completeness of submission by the bidders and facilitate examination by the BAC.

16. Deadline for Submission of Bids

16.1. The Bidders shall submit on the specified date and time and either at its physical address as indicated in paragraph 7 of the **IB**.

17. Opening and Preliminary Examination of Bids

17.1. The BAC shall open the Bids in public at the time, on the date, and at the place specified in paragraph 9 of the **IB**. The Bidders' representatives who are present shall sign a register evidencing their attendance.

In case the Bids cannot be opened as scheduled due to justifiable reasons, the rescheduling requirements under Section 29 of the 2016 revised IRR of RA No. 9184 shall prevail.

17.2. The preliminary examination of bids shall be governed by Section 30 of the 2016 revised IRR of RA No. 9184.

18. Domestic Preference

18.1. The Procuring Entity will grant a margin of preference for the purpose of comparison of Bids in accordance with Section 43.1.2 of the 2016 revised IRR of RA No. 9184.

19. Detailed Evaluation and Comparison of Bids

19.1. The Procuring BAC shall immediately conduct a detailed evaluation of all Bids rated "*passed*," using non-discretionary pass/fail criteria. The BAC shall consider the conditions in the evaluation of Bids under Section 32.2 of the 2016 revised IRR of RA No. 9184.

19.2. If the Project allows partial bids, bidders may submit a proposal on any of the lots or items, and evaluation will be undertaken on a per lot or item basis, as the case maybe. In this case, the Bid Security as required by **ITB** Clause 15 shall be submitted for each lot or item separately.

19.3. The descriptions of the lots or items shall be indicated in **Section VII (Technical Specifications)**, although the ABCs of these lots or items are indicated in the **BDS** for purposes of the NFCC computation pursuant to Section 23.4.2.6 of the 2016 revised IRR of RA No. 9184. The NFCC must be sufficient for the total of the ABCs for all the lots or items participated in by the prospective Bidder.

19.4. The Project shall be awarded as follows:

One Project having several items grouped into several lots, which shall be awarded as separate contracts per lot.

19.5. Except for bidders submitting a committed Line of Credit from a Universal or Commercial Bank in lieu of its NFCC computation, all Bids must include the NFCC computation pursuant to Section 23.4.1.4 of the 2016 revised IRR of RA No. 9184, which must be sufficient for the total of the ABCs for all the lots or items participated in by the prospective Bidder. For bidders submitting the committed Line of Credit, it must be at least equal to ten percent (10%) of the ABCs for all the lots or items participated in by the prospective Bidder.

20. Post-Qualification

20.2. Within a non-extendible period of five (5) calendar days from receipt by the Bidder of the notice from the BAC that it submitted the Lowest Calculated Bid, the Bidder shall submit its latest income and business tax returns filed and paid through the BIR Electronic Filing and Payment System (eFPS) and other appropriate licenses and permits required by law and stated in the **BDS**.

21. Signing of the Contract

21.1. The documents required in Section 37.2 of the 2016 revised IRR of RA No. 9184 shall form part of the Contract. Additional Contract documents are indicated in the **BDS**.

Section III. Bid Data Sheet

Notes on the Bid Data Sheet

The Bid Data Sheet (BDS) consists of provisions that supplement, amend, or specify in detail, information, or requirements included in the ITB found in Section II, which are specific to each procurement.

This Section is intended to assist the Procuring Entity in providing the specific information in relation to corresponding clauses in the ITB and has to be prepared for each specific procurement.

The Procuring Entity should specify in the BDS information and requirements specific to the circumstances of the Procuring Entity, the processing of the procurement, and the bid evaluation criteria that will apply to the Bids. In preparing the BDS, the following aspects should be checked:

- a. Information that specifies and complements provisions of the ITB must be incorporated.
- b. Amendments and/or supplements, if any, to provisions of the ITB as necessitated by the circumstances of the specific procurement, must also be incorporated.

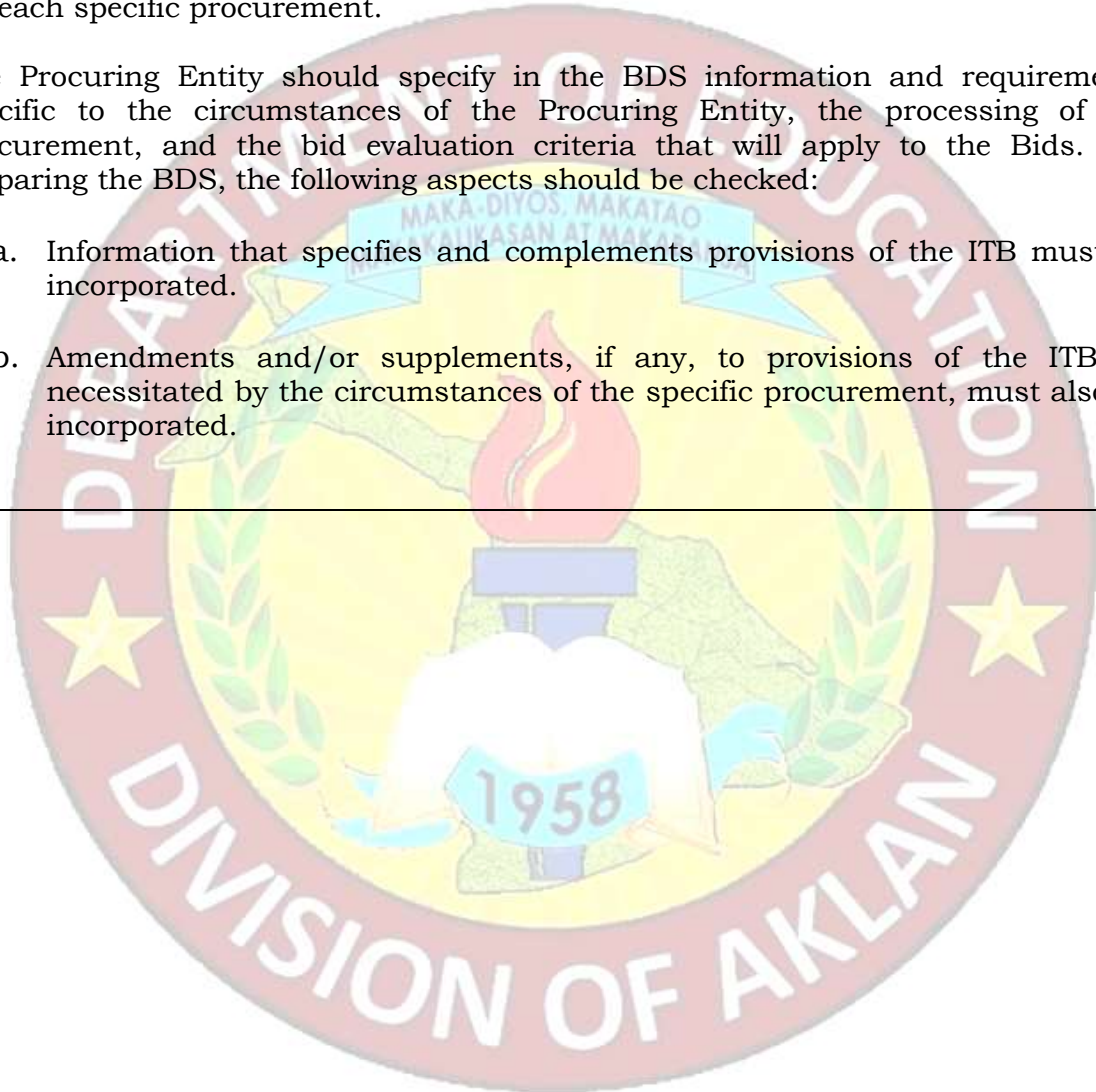

Bid Data Sheet

| ITB Clause | | | | | | | | | |
|-------------------|---|--|--------------------------------|--|--------------------------------|---|----------------------|------------------|------------------|
| 5.3 | <p>For this purpose, contracts similar to the Project shall be:</p> <p>a. School Furniture, and other related furniture.</p> <p>b. Completed within three (3) years prior to the deadline for the submission and receipt of bids.</p> | | | | | | | | |
| 12 | <p>The price of the Goods shall be quoted DDP DepEd Aklan Division Office, Poblacion, Numancia, Aklan.</p> | | | | | | | | |
| 14.1 | <p>The bid security shall be in the form of a Bid Securing Declaration, or any of the following forms and amounts:</p> <table border="1" data-bbox="408 734 1350 1003"> <thead> <tr> <th data-bbox="408 734 520 958">Lot</th> <th data-bbox="520 734 815 958">ABC</th> <th data-bbox="815 734 1142 958">Cash, Cashier's/manager's check, Bank draft/Guarantee or Irrevocable letter of credit (2% of ABC)</th> <th data-bbox="1142 734 1350 958">Surety Bond (5% of ABC)</th> </tr> </thead> <tbody> <tr> <td data-bbox="408 958 520 1003">1</td> <td data-bbox="520 958 815 1003">Php989,730.00</td> <td data-bbox="815 958 1142 1003">19,794.60</td> <td data-bbox="1142 958 1350 1003">49,486.50</td> </tr> </tbody> </table> | Lot | ABC | Cash, Cashier's/manager's check, Bank draft/Guarantee or Irrevocable letter of credit (2% of ABC) | Surety Bond (5% of ABC) | 1 | Php989,730.00 | 19,794.60 | 49,486.50 |
| Lot | ABC | Cash, Cashier's/manager's check, Bank draft/Guarantee or Irrevocable letter of credit (2% of ABC) | Surety Bond (5% of ABC) | | | | | | |
| 1 | Php989,730.00 | 19,794.60 | 49,486.50 | | | | | | |
| 19.3 | <p>Refer to Section VI. Schedule of Requirements</p> | | | | | | | | |
| 20.2 | <p>Within a non-extendible period of five (5) calendar days from receipt by the bidder of the notice from the BAC that it submitted the Lowest Calculated Bid, the Bidder shall submit the following requirements:</p> <p>a. Latest income and business tax returns:</p> <p>b. Certificate of PhilGEPS Registration (Platinum Membership); and</p> <p>c. Other appropriate licenses and permits required by law and stated in this BDS.</p> <p>During post-qualification, upon demand by the BAC or its representative(s), a bidder with the lowest calculated bid shall be able to present:</p> <p>a) Documents to verify or support its Statement of On-going and/ or Statement identifying its Single Largest Completed Contract which may consist of the following: appropriate and clear duly signed contracts, purchase orders, agreements, notices of award, job orders, or notices to proceed, with the corresponding duly signed certificate of completion, delivery receipts, inspection and acceptance reports, certificates of final acceptance or official receipts.</p> <p>b) Original copy of the submitted eligibility, technical and financial documents during bid opening</p> <p>Failure to submit above requirements within the required timeframe or a finding against the veracity of any such documents or other documents</p> | | | | | | | | |

submitted for the project shall be a ground for disqualification of the bidder for the award and the enforcement of the bid securing declaration. To facilitate post-qualification, the bidder at its option may submit in advance, i.e., on the deadline for submission and receipt of bids, above requirements and other documents required in Section II. ITB 29.2. The envelope shall be placed in a brown envelope and marked:

ITB 29.2 Documents

Name of Project: _____

Bid Opening Date: _____

Name of Bidder: _____

However, non-submission of these documents in advance will not disqualify the bidder during the opening and examination of bids.

Submission of Samples

In addition to the documentary requirements to be submitted during post-qualification as provided under ITB Clause 29.2 (a) to (c), the bidder/s having the Lowest Calculated Bid/s shall submit sample for all the items within the lot/s being bid for based on the technical specifications as indicated in Section VII. Technical Specifications during Post-qualification.

These samples shall be subjected to evaluation during post-qualification to determine compliance of the said bidder/s with DepEd Technical Specifications requirements.

The bidder shall submit one (1) set of samples. If the bidder submits one (1) set of samples for specific item that is similar in another lot, the submission shall be deemed a submission for the same items in other lots, unless a contrary intention is categorically made by the bidder in writing.

Failure to submit the required samples on or before the deadline date and time for submission shall be ground for rejection of bids. The technical working group (TWG) shall evaluate the said sample to determine the compliance with the required technical specifications. Failure to comply thereto shall be a ground for post-disqualification. Subject to the approval of the bids and awards committee (BAC).

Failure of the samples to meet DepEd specifications shall be a ground for disqualification of the bidder/s.

Testing Procedures (For Samples)

1. One (1) bidder representative per LCB shall be allowed to present the items for evaluation.
2. During the testing period, only the authorized representative of the bidder having the lowest calculated bid/s shall conduct the testing under the direction of the BAC and TWG. He/She shall be assigned in the area specifically designated for the bidder.
3. Bidders are allowed to bring and simultaneously present two (2) sets of samples. Bidders need only to pass the test for one (1) set of

| | |
|------|--|
| | <p>samples. If both samples fail then the testing fails. However, if the bidder opted to bring only one set of samples and the said set of samples fails, the bidder may no longer replace the said samples.</p> <ol style="list-style-type: none"> 4. The tests will be conducted by item. 5. During the testing, LCB Bidders are allowed to observe but not beyond the designated area. Only one (1) authorized representative per bidder is allowed 6. The testing will be held within DepEd at a venue still to be determined. 7. The testing must be conducted on a fixed schedule. 8. If a bidder bids for and wins several lots, it shall be tested for one set up. If the test fails, then it fails in all lots. 9. At least one BAC member must be present during the testing. 10. Only TWG and BAC members present are authorized to conduct the testing. |
| 21.2 | <p><i>[List here any additional contract documents relevant to the Project that may be required by existing laws and/or the Procuring Entity.]</i> NA</p> |

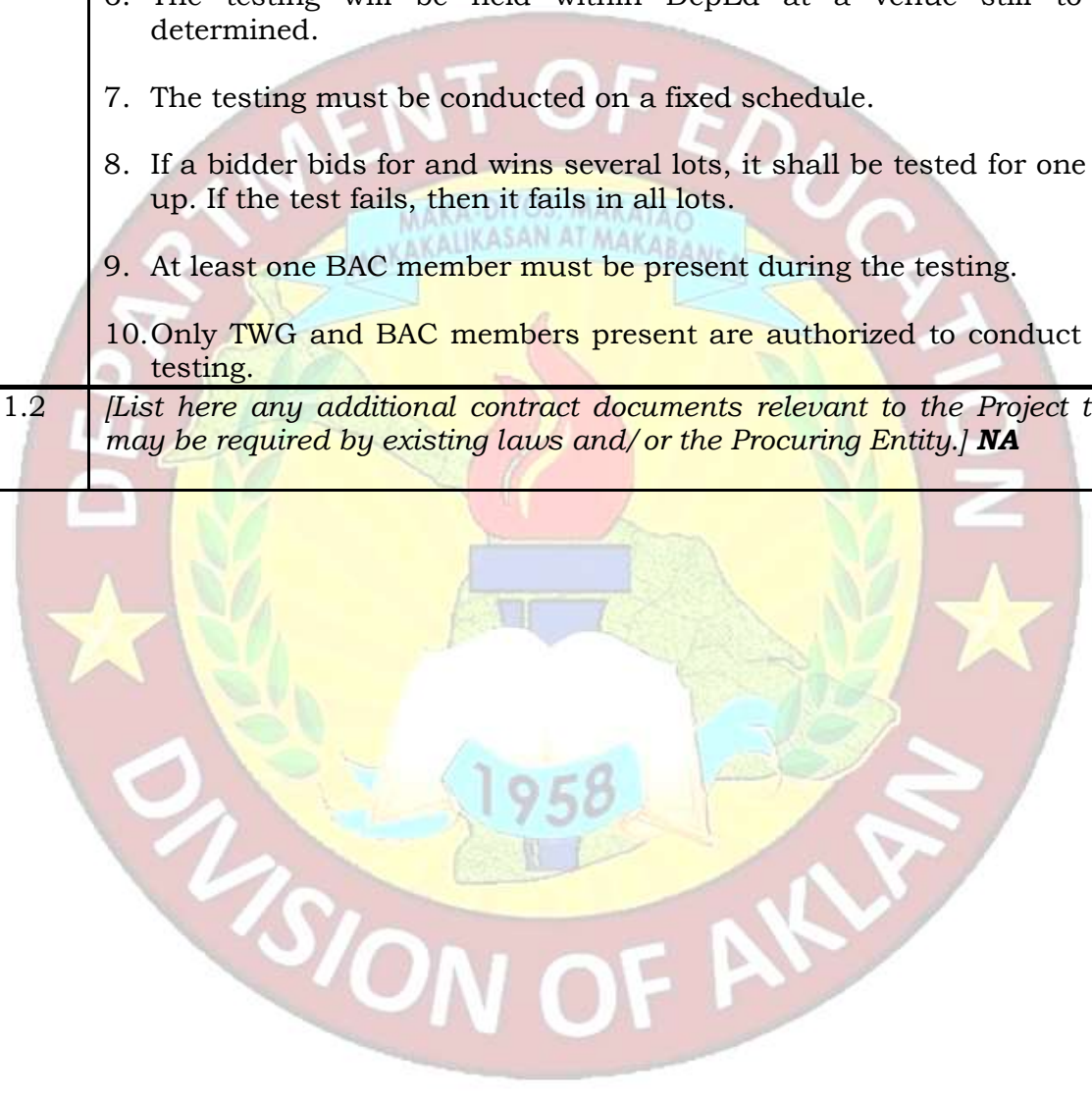

Section IV. General Conditions of Contract

Notes on the General Conditions of Contract

The General Conditions of Contract (GCC) in this Section, read in conjunction with the Special Conditions of Contract in Section V and other documents listed therein, should be a complete document expressing all the rights and obligations of the parties.

Matters governing performance of the Supplier, payments under the contract, or matters affecting the risks, rights, and obligations of the parties under the contract are included in the GCC and Special Conditions of Contract.

Any complementary information, which may be needed, shall be introduced only through the Special Conditions of Contract.

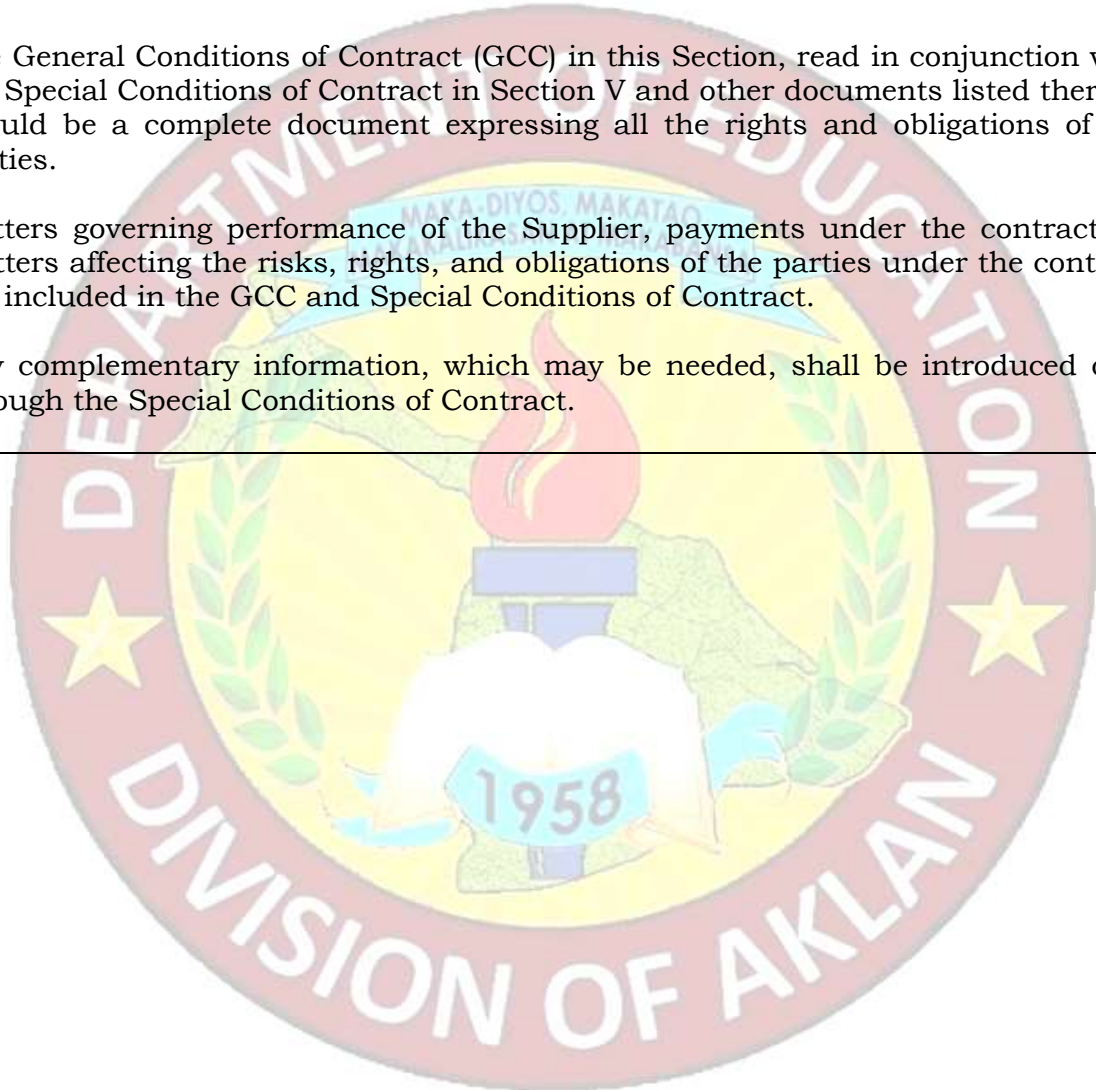

1. Scope of Contract

This Contract shall include all such items, although not specifically mentioned, that can be reasonably inferred as being required for its completion as if such items were expressly mentioned herein. All the provisions of RA No. 9184 and its 2016 revised IRR, including the Generic Procurement Manual, and associated issuances, constitute the primary source for the terms and conditions of the Contract, and thus, applicable in contract implementation. Herein clauses shall serve as the secondary source for the terms and conditions of the Contract.

This is without prejudice to Sections 74.1 and 74.2 of the 2016 revised IRR of RA No. 9184 allowing the GPPB to amend the IRR, which shall be applied to all procurement activities, the advertisement, posting, or invitation of which were issued after the effectivity of the said amendment.

Additional requirements for the completion of this Contract shall be provided in the **Special Conditions of Contract (SCC)**.

2. Advance Payment and Terms of Payment

2.1. Advance payment of the contract amount is provided under Annex “D” of the revised 2016 IRR of RA No. 9184.

2.2. The Procuring Entity is allowed to determine the terms of payment on the partial or staggered delivery of the Goods procured, provided such partial payment shall correspond to the value of the goods delivered and accepted in accordance with prevailing accounting and auditing rules and regulations. The terms of payment are indicated in the **SCC**.

3. Performance Security

Within ten (10) calendar days from receipt of the Notice of Award by the Bidder from the Procuring Entity but in no case later than prior to the signing of the Contract by both parties, the successful Bidder shall furnish the performance security in any of the forms prescribed in Section 39 of the 2016 revised IRR of RA No. 9184.

4. Inspection and Tests

The Procuring Entity or its representative shall have the right to inspect and/or to test the Goods to confirm their conformity to the Project specifications at no extra cost to the Procuring Entity in accordance with the Generic Procurement Manual. In addition to tests in the **SCC, Section IV (Technical Specifications)** shall specify what inspections and/or tests the Procuring Entity requires, and where they are to be conducted. The Procuring Entity shall notify the Supplier in writing, in a timely manner, of the identity of any representatives retained for these purposes.

All reasonable facilities and assistance for the inspection and testing of Goods, including access to drawings and production data, shall be provided by the Supplier to the authorized inspectors at no charge to the Procuring Entity.

5. Warranty

- 5.1 In order to assure that manufacturing defects shall be corrected by the Supplier, a warranty shall be required from the Supplier as provided under Section 62.1 of the 2016 revised IRR of RA No. 9184.
- 5.2 The Procuring Entity shall promptly notify the Supplier in writing of any claims arising under this warranty. Upon receipt of such notice, the Supplier shall, repair or replace the defective Goods or parts thereof without cost to the Procuring Entity, pursuant to the Generic Procurement Manual.

6. Liability of the Supplier

The Supplier's liability under this Contract shall be as provided by the laws of the Republic of the Philippines.

If the Supplier is a joint venture, all partners to the joint venture shall be jointly and severally liable to the Procuring Entity.

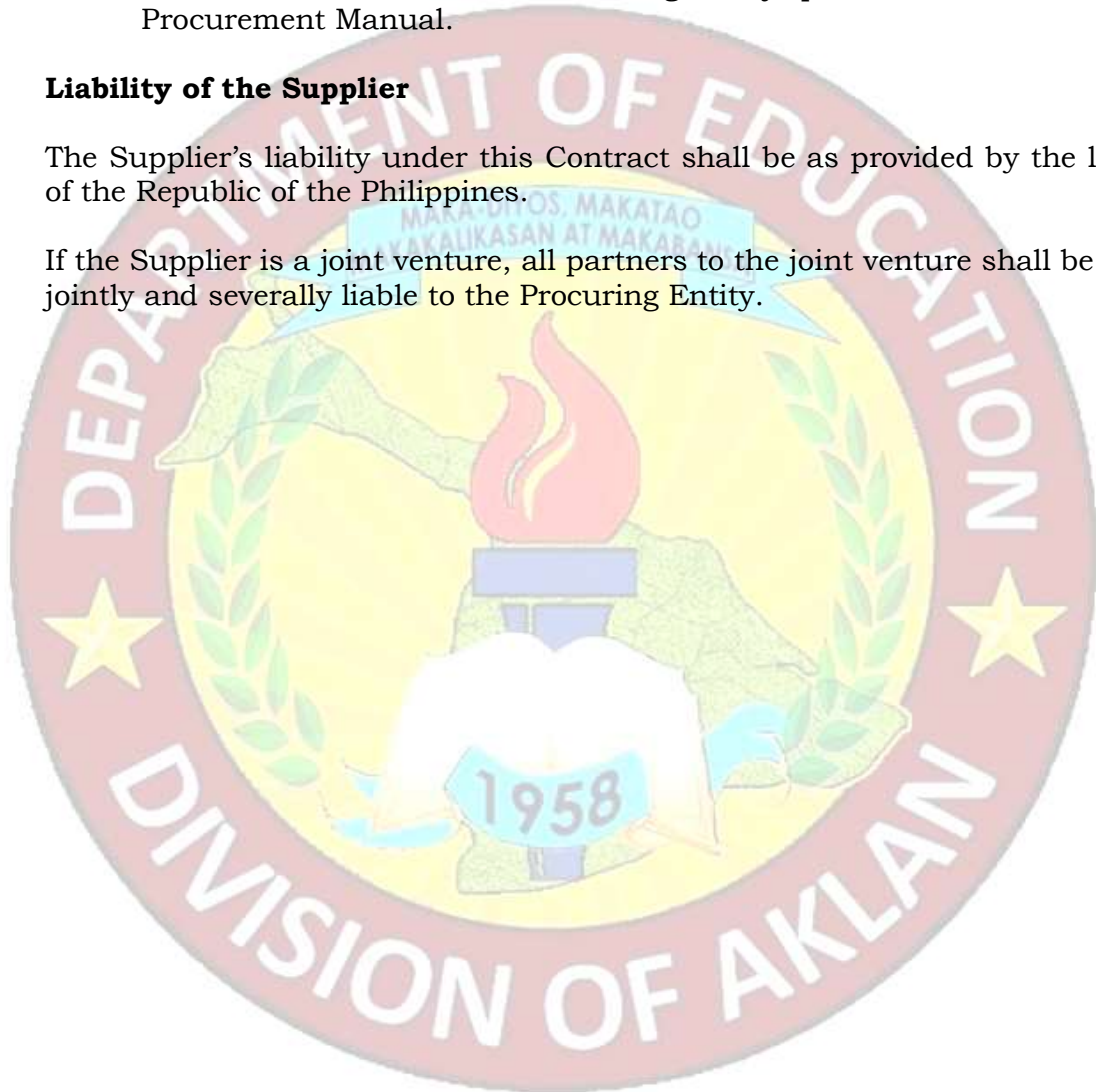

Section V. Special Conditions of Contract

Notes on the Special Conditions of Contract

Similar to the BDS, the clauses in this Section are intended to assist the Procuring Entity in providing contract-specific information in relation to corresponding clauses in the GCC found in Section IV.

The Special Conditions of Contract (SCC) complement the GCC, specifying contractual requirements linked to the special circumstances of the Procuring Entity, the Procuring Entity's country, the sector, and the Goods purchased. In preparing this Section, the following aspects should be checked:

- a. Information that complements provisions of the GCC must be incorporated.
- b. Amendments and/or supplements to provisions of the GCC as necessitated by the circumstances of the specific purchase, must also be incorporated.

However, no special condition which defeats or negates the general intent and purpose of the provisions of the GCC should be incorporated herein.

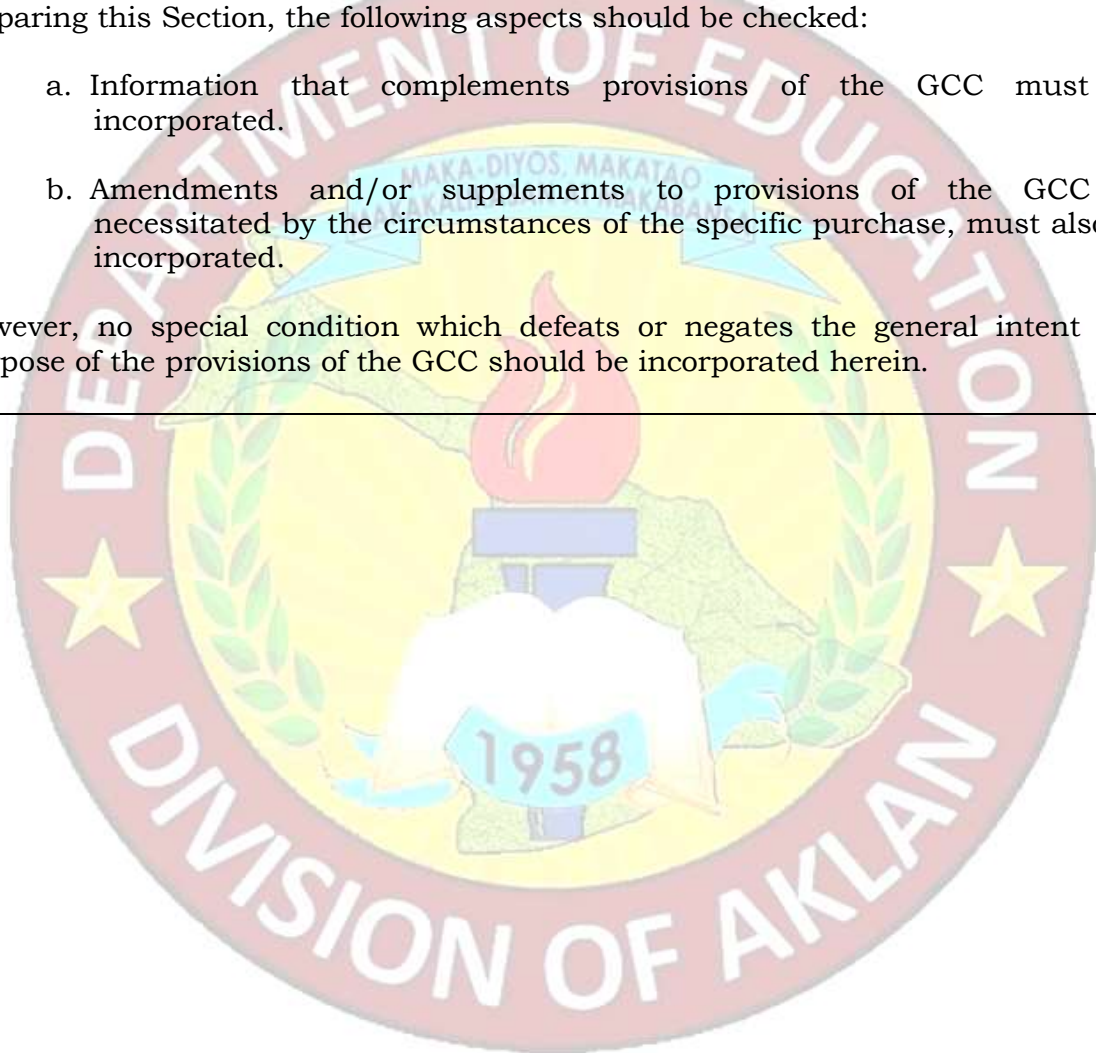

Special Conditions of Contract

| GCC Clause | |
|------------|---|
| 1 | <p>Delivery and Documents –</p> <p>For purposes of the Contract, “EXW,” “FOB,” “FCA,” “CIF,” “CIP,” “DDP” and other trade terms used to describe the obligations of the parties shall have the meanings assigned to them by the current edition of INCOTERMS published by the International Chamber of Commerce, Paris. The Delivery terms of this Contract shall be as follows:</p> <p>The delivery terms applicable to this Contract are delivered at door to door delivery at the school site. Risk and title will pass from the Supplier to the Procuring Entity upon receipt and final acceptance of the Goods at their final destination.</p> <p>Delivery of the Goods shall be made by the Supplier in accordance with the terms specified in Section VI (Schedule of Requirements).</p> <p>For purposes of this Clause the Procuring Entity’s Representative at the Project Site is Mrs. Mildred B. Zante, Admin. Officer IV (Supply Officer).</p> <p>Incidental Services –</p> <p>The Supplier is required to provide all of the following services, including additional services, if any, specified in Section VI. Schedule of Requirements: <i>Select appropriate requirements and delete the rest.</i></p> <ul style="list-style-type: none"> a. performance or supervision of on-site assembly and/or start-up of the supplied Goods; b. furnishing of tools required for assembly and/or maintenance of the supplied Goods; c. furnishing of a detailed operations and maintenance manual for each appropriate unit of the supplied Goods; d. performance or supervision or maintenance and/or repair of the supplied Goods, for a period of time agreed by the parties, provided that this service shall not relieve the Supplier of any warranty obligations under this Contract; and |
| | <ul style="list-style-type: none"> e. training of the Procuring Entity’s personnel, at the Supplier’s plant and/or on-site, in assembly, start-up, operation, maintenance, and/or repair of the supplied Goods. <p>The Contract price for the Goods shall include the prices charged by the Supplier for incidental services and shall not exceed the prevailing rates charged to other parties by the Supplier for similar services.</p> |

Spare Parts –

The Supplier is required to provide all of the following materials, notifications, and information pertaining to spare parts manufactured or distributed by the Supplier:

Select appropriate requirements and delete the rest.

- a. such spare parts as the Procuring Entity may elect to purchase from the Supplier, provided that this election shall not relieve the Supplier of any warranty obligations under this Contract; and
- b. in the event of termination of production of the spare parts:
 - i. advance notification to the Procuring Entity of the pending termination, in sufficient time to permit the Procuring Entity to procure needed requirements; and
 - ii. following such termination, furnishing at no cost to the Procuring Entity, the blueprints, drawings, and specifications of the spare parts, if requested.

The spare parts and other components required are listed in **Section VI (Schedule of Requirements)** and the cost thereof are included in the contract price.

The Supplier shall carry sufficient inventories to assure ex-stock supply of consumable spare parts or components for the Goods for a period of *[indicate here the time period specified. If not used indicate a time period of three times the warranty period]*.

Spare parts or components shall be supplied as promptly as possible, but in any case, within *[insert appropriate time period]* months of placing the order.

Packaging –

The Supplier shall provide such packaging of the Goods as is required to prevent their damage or deterioration during transit to their final destination, as indicated in this Contract. The packaging shall be sufficient to withstand, without limitation, rough handling during transit and exposure to extreme temperatures, salt and precipitation during transit, and open storage. Packaging case size and weights shall take into consideration, where appropriate, the remoteness of the Goods' final destination and the absence of heavy handling facilities at all points in transit.

The packaging, marking, and documentation within and outside the packages shall comply strictly with such special requirements as shall be expressly provided for in the Contract, including additional requirements, if any, specified below, and in any subsequent

| | |
|--|--|
| | <p>instructions ordered by the Procuring Entity.</p> <p>The outer packaging must be clearly marked on at least four (4) sides as follows:</p> <p>Name of the Procuring Entity Name of the Supplier Contract Description Final Destination Gross weight Any special lifting instructions Any special handling instructions Any relevant HAZCHEM classifications</p> |
| | <p>A packaging list identifying the contents and quantities of the package is to be placed on an accessible point of the outer packaging if practical. If not practical the packaging list is to be placed inside the outer packaging but outside the secondary packaging.</p> <p>Transportation -</p> <p>Where the Supplier is required under Contract to deliver the Goods CIF, CIP, or DDP, transport of the Goods to the port of destination or such other named place of destination in the Philippines, as shall be specified in this Contract, shall be arranged and paid for by the Supplier, and the cost thereof shall be included in the Contract Price.</p> <p>Where the Supplier is required under this Contract to transport the Goods to a specified place of destination within the Philippines, defined as the Project Site, transport to such place of destination in the Philippines, including insurance and storage, as shall be specified in this Contract, shall be arranged by the Supplier, and related costs shall be included in the contract price.</p> |
| | <p>The Procuring Entity accepts no liability for the damage of Goods during transit other than those prescribed by INCOTERMS for DDP deliveries. In the case of Goods supplied from within the Philippines or supplied by domestic Suppliers risk and title will not be deemed to have passed to the Procuring Entity until their receipt and final acceptance at the final destination.</p> <p>Intellectual Property Rights -</p> <p>The Supplier shall indemnify the Procuring Entity against all third-party claims of infringement of patent, trademark, or industrial design rights arising from use of the Goods or any part thereof.</p> |

2.2

Schedule of Payment –

The method and conditions of payment to be made to the Supplier through the Government disbursement procedure within sixty (60) days from submission of documents under this Contract shall be as follows:

a. Final Payment:

100% of payment upon completion of the project.

Payment shall be made only after all of the following requirements have been submitted:

a. Request for Payment

b. Copy of Contract

c. Certification issued by the Procuring Entity that the delivered goods have been duly inspected and accepted

d. Signed Delivery Receipts

e. Signed Inspection and Acceptance Report (IAR)

4

The inspections and tests that will be conducted are: *[Indicate the applicable inspections and tests]*

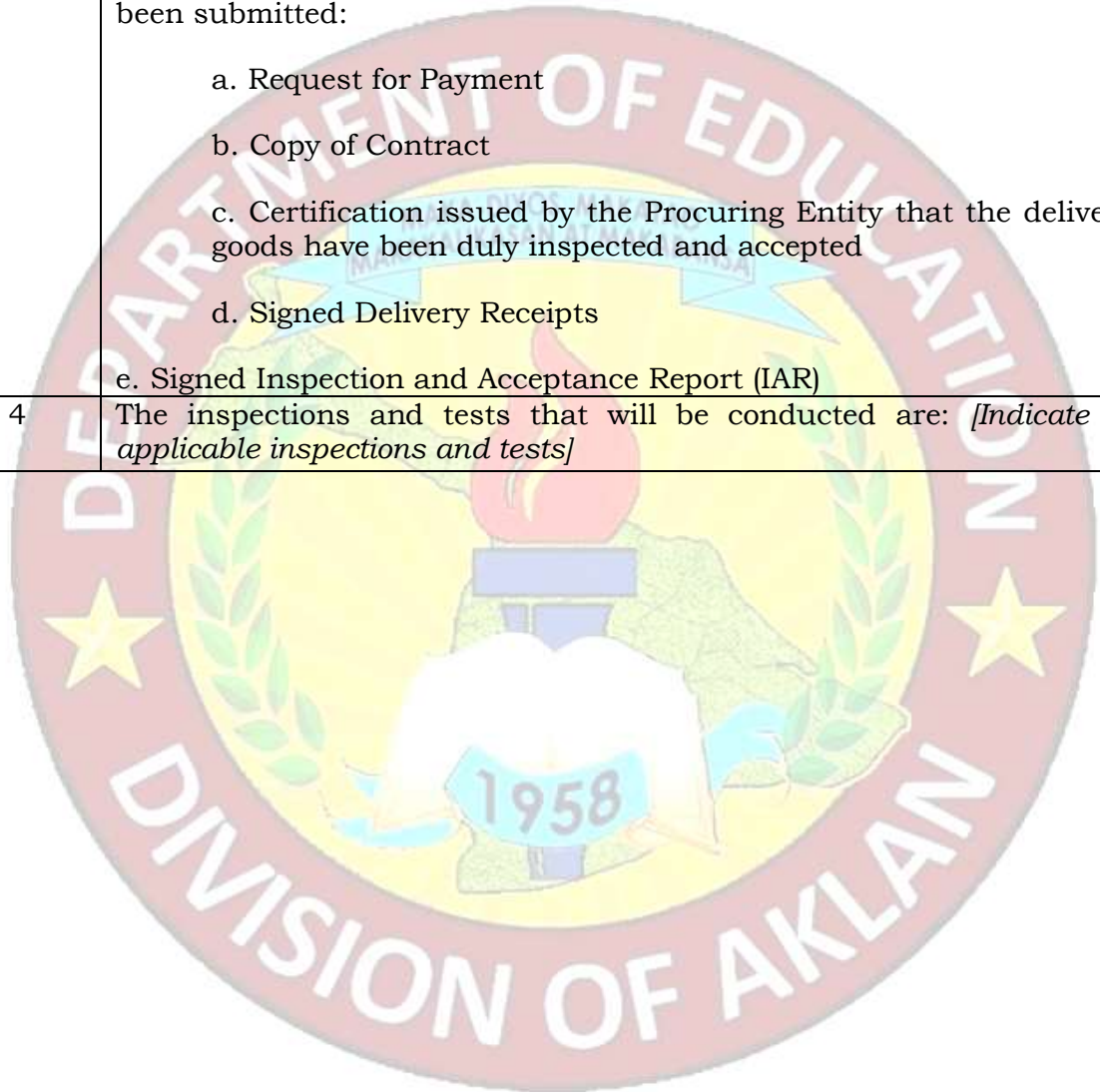

Section VI. Schedule of Requirements

The delivery schedule expressed as weeks/months stipulates hereafter a delivery date which is the date of delivery to the project site.

For Office Supplies:

| Item No. | Unit | Description | Qty. | Total | Delivered, Weeks/Months |
|-----------------|-------------|--------------------------------------|---------------------------------|--------------|--------------------------------|
| 1. | set | Individual Learner Table & Chair Set | 180 (Senior High School) | | |
| 2. | set | Teacher's Table & Chair Set | 4 | | |
| 3. | set | Individual Learner Table & Chair Set | 135 (Senior High School) | | |
| 4. | set | Teacher's Table & Chair Set | 3 | | |

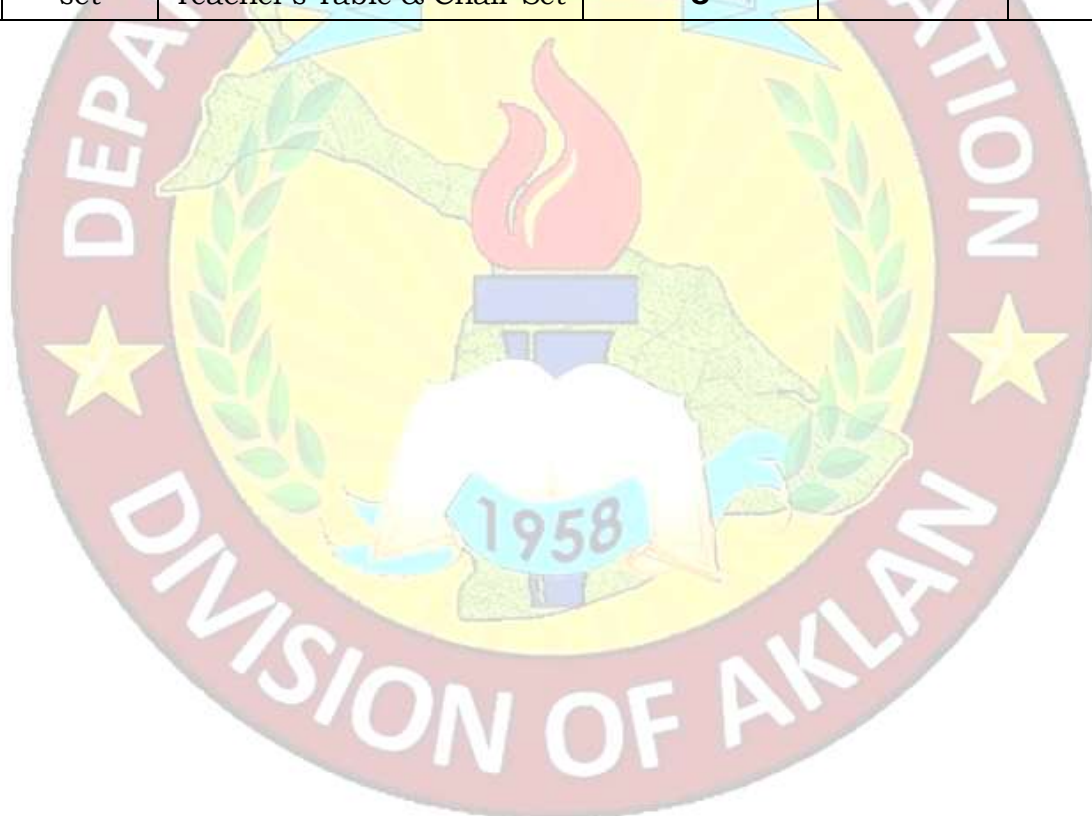

Section VII. Technical Specifications

Notes for Preparing the Technical Specifications

A set of precise and clear specifications is a prerequisite for Bidders to respond realistically and competitively to the requirements of the Procuring Entity without qualifying their Bids. In the context of Competitive Bidding, the specifications (*e.g.* production/delivery schedule, manpower requirements, and after-sales service/parts, descriptions of the lots or items) must be prepared to permit the widest possible competition and, at the same time, present a clear statement of the required standards of workmanship, materials, and performance of the goods and services to be procured. Only if this is done will the objectives of transparency, equity, efficiency, fairness, and economy in procurement be realized, responsiveness of bids be ensured, and the subsequent task of bid evaluation and post-qualification facilitated. The specifications should require that all items, materials and accessories to be included or incorporated in the goods be new, unused, and of the most recent or current models, and that they include or incorporate all recent improvements in design and materials unless otherwise provided in the Contract.

Samples of specifications from previous similar procurements are useful in this respect. The use of metric units is encouraged. Depending on the complexity of the goods and the repetitiveness of the type of procurement, it may be advantageous to standardize the General Technical Specifications and incorporate them in a separate subsection. The General Technical Specifications should cover all classes of workmanship, materials, and equipment commonly involved in manufacturing similar goods. Deletions or addenda should then adapt the General Technical Specifications to the particular procurement.

Care must be taken in drafting specifications to ensure that they are not restrictive. In the specification of standards for equipment, materials, and workmanship, recognized Philippine and international standards should be used as much as possible. Where other particular standards are used, whether national standards or other standards, the specifications should state that equipment, materials, and workmanship that meet other authoritative standards, and which ensure at least a substantially equal quality than the standards mentioned, will also be acceptable. The following clause may be inserted in the Special Conditions of Contract or the Technical Specifications.

Sample Clause: Equivalency of Standards and Codes

Wherever reference is made in the Technical Specifications to specific standards and codes to be met by the goods and materials to be furnished or tested, the provisions of the latest edition or revision of the relevant standards and codes shall apply, unless otherwise expressly stated in the Contract. Where such standards and codes are national or relate to a particular country or region, other authoritative standards that ensure substantial equivalence to the standards and codes specified will be acceptable.

Reference to brand name and catalogue number should be avoided as far as possible; where unavoidable they should always be followed by the words “*or at*

least equivalent.” References to brand names cannot be used when the funding source is the GOP.

Where appropriate, drawings, including site plans as required, may be furnished by the Procuring Entity with the Bidding Documents. Similarly, the Supplier may be requested to provide drawings or samples either with its Bid or for prior review by the Procuring Entity during contract execution.

Bidders are also required, as part of the technical specifications, to complete their statement of compliance demonstrating how the items comply with the specification.

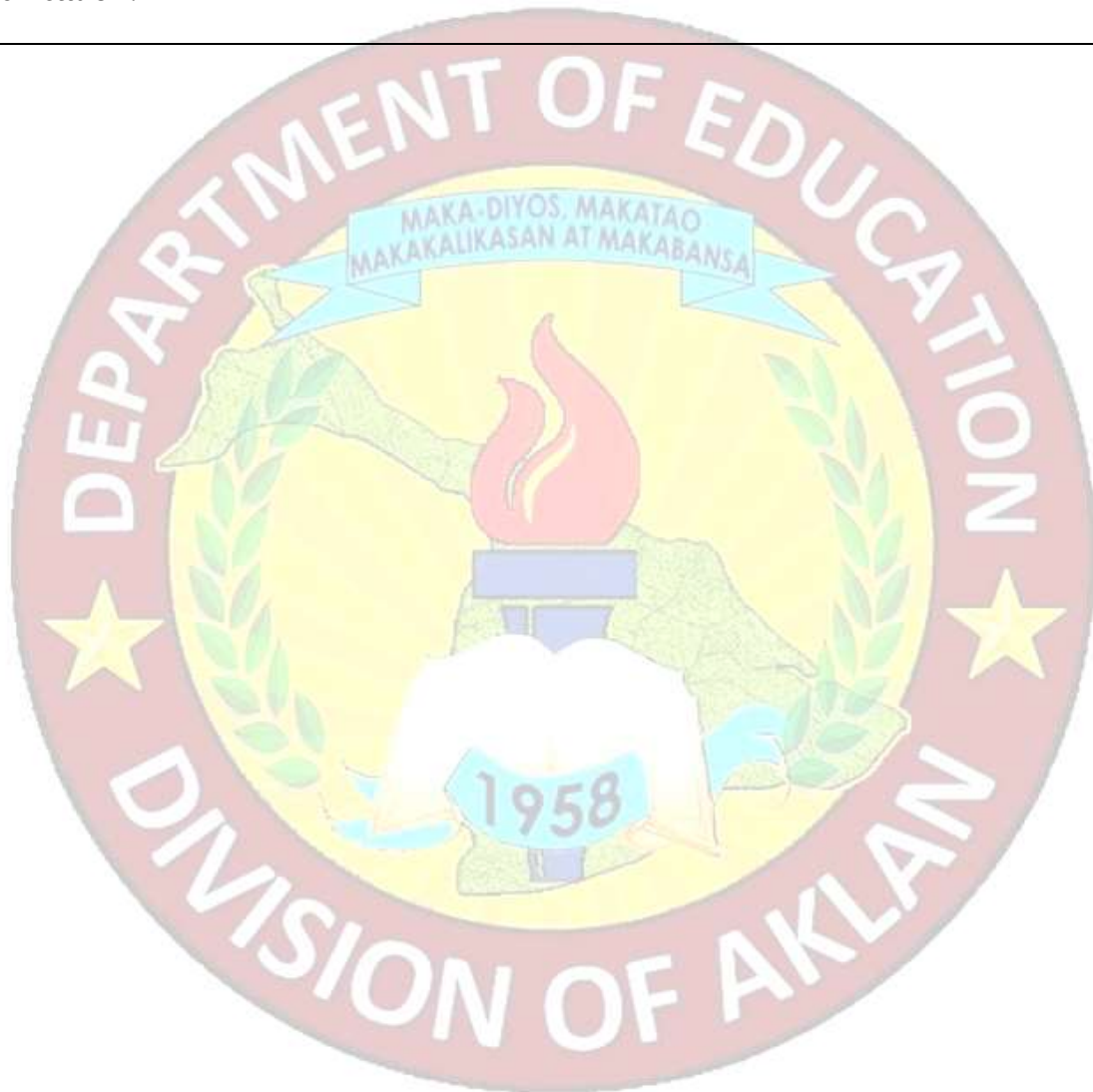

Technical Specifications

| Item | Specification | Statement of Compliance |
|------|---------------|---|
| | | <p><i>[Bidders must state here either “Comply” or “Not Comply” against each of the individual parameters of each Specification stating the corresponding performance parameter of the equipment offered. Statements of “Comply” or “Not Comply” must be supported by evidence in a Bidders Bid and cross-referenced to that evidence. Evidence shall be in the form of manufacturer’s un-amended sales literature, unconditional statements of specification and compliance issued by the manufacturer, samples, independent test data etc., as appropriate. A statement that is not supported by evidence or is subsequently found to be contradicted by the evidence presented will render the Bid under evaluation liable for rejection. A statement either in the Bidder’s statement of compliance or the supporting evidence that is found to be false either during Bid evaluation, post-qualification or the execution of the Contract may be regarded as fraudulent and render the Bidder or supplier liable for prosecution subject to the applicable laws and issuances.]</i></p> |

DEPED LOGO SPECIFICATIONS FOR ALL LEARNER AND TEACHER'S CHAIR

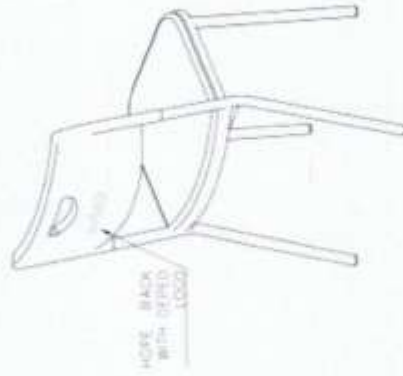
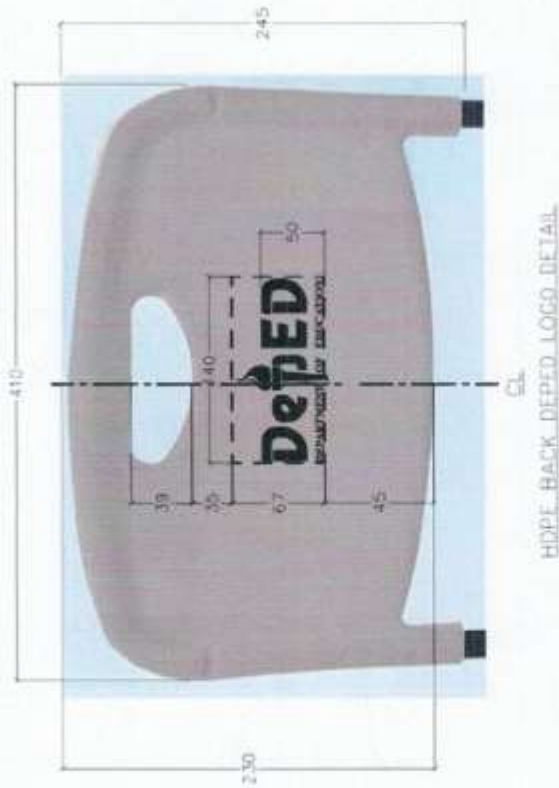

SPECIFICATIONS:

1. MATERIAL: BLOW MOLDED HDPE.
 2. MARKINGS: MINIMUM OF 0.8MM DEPTH EMBOSSED / MOLDED OFFICIAL "DepEd Logo" WITH THE INSCRIPTION "DEPARTMENT OF EDUCATION" AS PER DRAWING.
 3. COLOR CODE: PANTONE 4665C OR COLOR HEX: #cda788 / RGB: 205, 167, 136 / CMYK: 0%, 19%, 34%, 20%
 4. DEPED LOGO COLOR IS THE SAME AS BACKREST COLOR CODE.
- NOTE: BLACK COLOR OF LOGO SHOWN IS FOR ILLUSTRATION ONLY.



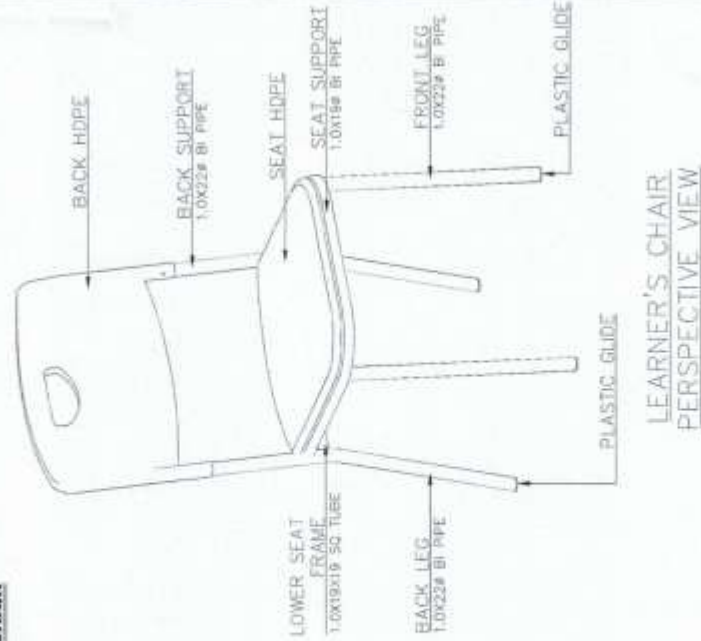
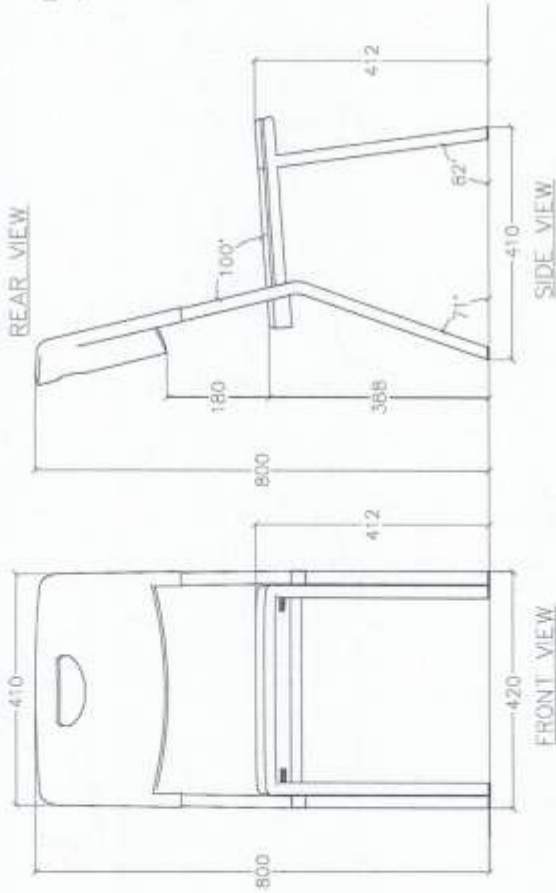
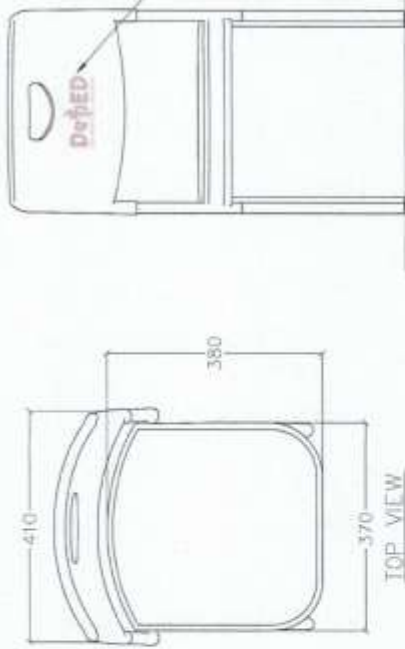

| | | | | | | |
|--|--|--|--|---|---|------------------------|
| | | | | <p>PROJECT TITLE LEARNER & TEACHER'S CHAIR - HDPE BACK DEPED LOGO DETAIL (HDPE & STEEL)</p> | <p>DEPT. DIVISION DEPED DIVISION OFFICE MARIKINA CITY</p> | <p>SHEET NO. 1</p> |
|--|--|--|--|---|---|------------------------|

DEPED SECONDARY LEARNER'S CHAIR

DEPED LOGO SPECIFICATIONS FOR ALL LEARNER AND TEACHER'S CHAIR



LEARNER'S CHAIR PERSPECTIVE VIEW

| | | | | | | |
|--|--|--|---|---|--|-------------------|
|  DEPED DIVISION OFFICE DIVISION OF EDUCATION MALABON CITY | DESIGN BY:  21 TORRES BLVD. MALABON CITY | DOMESTIC SUPPLIER:  DNE SHELLEY PANG |  DIVISION OFFICE MALABON CITY | PROJECT USE: LEARNER'S CHAIR (HDPE & STEEL) | SHEET AREA: SECONDARY LEARNER'S CHAIR - PERSPECTIVE VIEW - 30' X 40' - - 20' X 40' - - 10' X 40' - - 10' X 20' - | SHEET NO.: 4 5 |
| | DEPED SECONDARY LEARNER'S CHAIR | | | | | |

DEPED SECONDARY LEARNER'S CHAIR

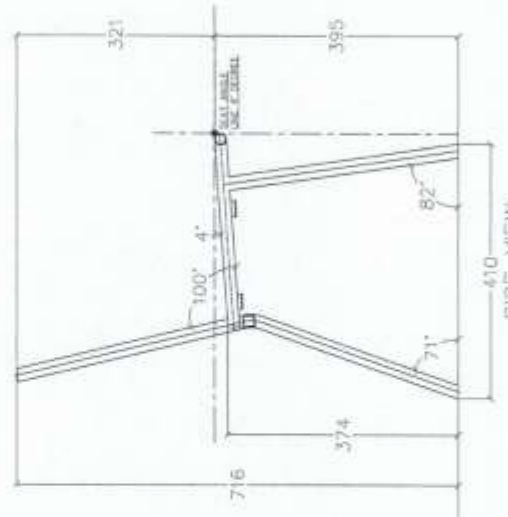
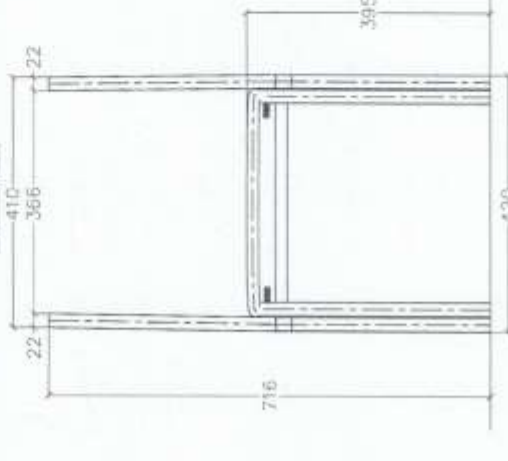
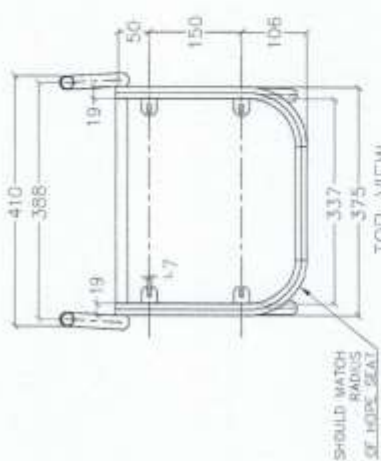
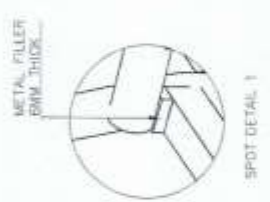
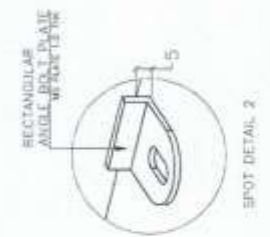
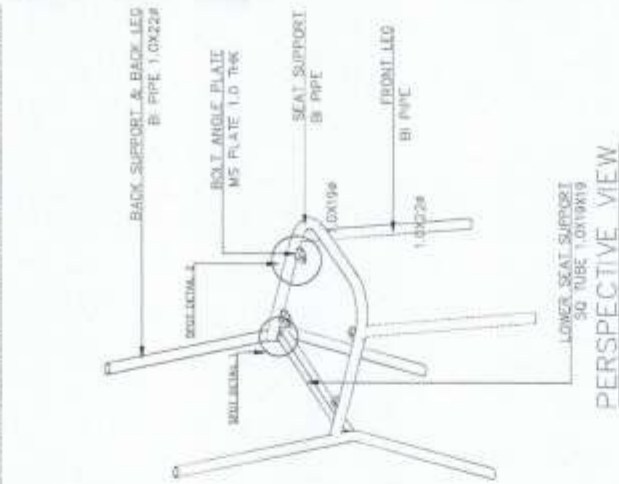



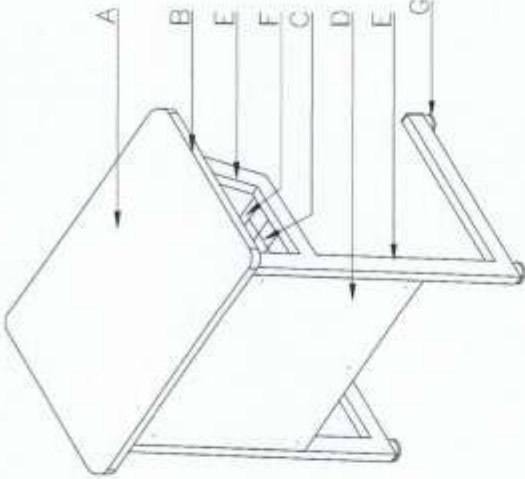

| | | | | | |
|--|---|---|------------------------------|---|-----------------|
| | NUMBER OF: AT: SAVED PLANNING DIVISION | NUMBER OF SETS: DIVISION | APPROVED BY: DIVISION | PROJECT TITLE: LEARNER'S CHAIR (HOPE & STEEL) | SHEET NO.: 5 |
| | DESIGNED BY: SECONDARY LEARNER'S CHAIR | CHECKED BY: APPROVED BY: DIVISION | SHEET NO.: 5 | PROJECT NO.: C-207 | SHEET NO.: 5 |

| 1 | | TECHNICAL SPECIFICATIONS OF LEARNER'S TABLE | |
|------|--|--|--|
| MARK | COMPONENTS | SPECIFICATIONS | |
| A | TABLE TOP | 18MM THK TOP BOARD ROUND CORNERS (1 SIDE 1.0MM THK HIGH PRESSURE LAMINATE / 1 SIDE VARNISH FINISHES ON MARINE PLYWOOD) | |
| B | EDGING | 1.0 MM THK PVC EDGING, ALL EDGES OF TABLE TOP | |
| C | SHELF | METAL WIRE MESH 4MMTHKX50X50 | |
| D | FRONT COVER | 6MM THK FRONT COVER (1 SIDE 1.0MM THK HIGH PRESSURE LAMINATE / 1 SIDE VARNISH FINISHES ON MARINE PLYWOOD) | |
| E | MAIN FRAME | 1.0MMTHKX20MMX40MM STEEL TUBULAR | |
| F | SECONDARY FRAME | 1.0MMTHKX20MMX20MM STEEL TUBULAR | |
| G | ADJUSTABLE LEVELER | 8MM6 THREAD WITH 30MM6 PLASTIC BASE | |
| | CONNECTOR/FLAT BAR | 10MMTHKX22MMX50MM STEEL FLAT BAR (TABLE TOP-4PCS;SCREW) | |
| | CONNECTION | WOOD TO STEEL: SCREW M5X12MM LENGTH; SCREW RIVETS: BILD RIVET | |
| | | STEEL TO STEEL: FULL WELDING FOR TUBULAR TO FLAT BAR/CONNECTION | |
| | | STEEL TO STEEL: (M6X20X20MM)-BOLT AND NUT FOR STEEL TUBULAR | |
| | | NO DESIGN IS FOR BODDER TO PROPOSE | |
| 2a | SCHEDULE OF FINISHES | | |
| | TOP BOARD | 1 SIDE 1.0MM THK HIGH PRESSURE LAMINATE / 1 SIDE VARNISH FINISHES ON MARINE PLYWOOD | |
| | EDGING | 1.0 MM THK PVC EDGING, ALL EDGES OF TABLE TOP | |
| | FRONT COVER | 1 SIDE 1.0MM THK HIGH PRESSURE LAMINATE / 1 SIDE VARNISH FINISHES ON MARINE PLYWOOD | |
| | METAL/STEEL TUBULAR | 60-80 MICRON POWDER COAT FINISH FLAT BLACK PRISH | |
| | LAMINATE COLOR | PANTONE 759C OR COLOR PEX #57-45 / RGB 161, 134, 69 / CMYK 0%, 33%, 63%, 37% WITH WOOD GRAIN (SERVAND BEECH OR EQUIVALENT) | |
| 2b | EDGING -- APPLICATION | | |
| 1 | MACHINE APPLICATION OF GLUE TO TABLE TOP EDGES | | |
| 2 | MACHINE APPLICATION OF PVC EDGING TO TABLE TOP EDGES | | |

| 3 | | DIMENSIONS OF LEARNER'S TABLE(mm) | |
|------|--------------|-----------------------------------|-----------|
| MARK | COMPONENTS | ELEMENTARY | SECONDARY |
| a | TABLE HEIGHT | 670 (+10) | 710 (+10) |
| b | TABLE LENGTH | 600 | 650 |
| c | TABLE WIDTH | 400 | 400 |



ISOMETRIC VIEW OF LEARNER'S TABLE
SCALE 1:1

| LEARNER'S TABLE (WOOD & STEEL) | | MARK NO. |
|--|--|----------|
| DESIGNED BY:  ANAND K. NAIR | DESIGNED BY:  ANAND K. NAIR | 1 |
| DESIGNED BY:  ANAND K. NAIR | DESIGNED BY:  ANAND K. NAIR | 3 |

DEPED ELEMENTARY SINGLE LEARNER'S TABLE

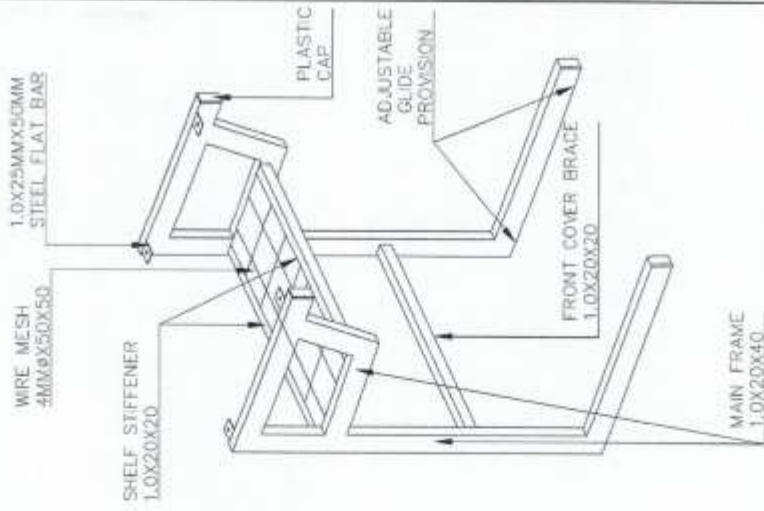
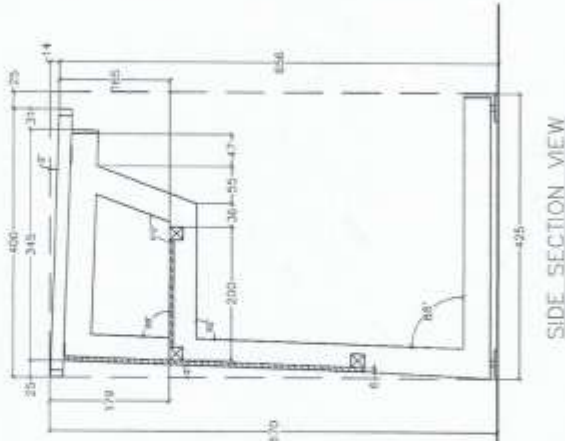
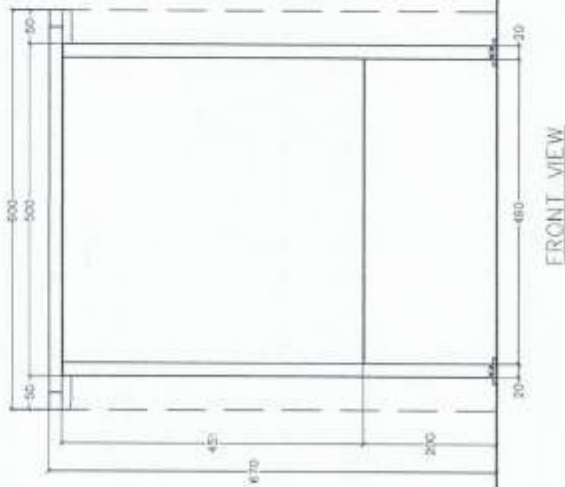
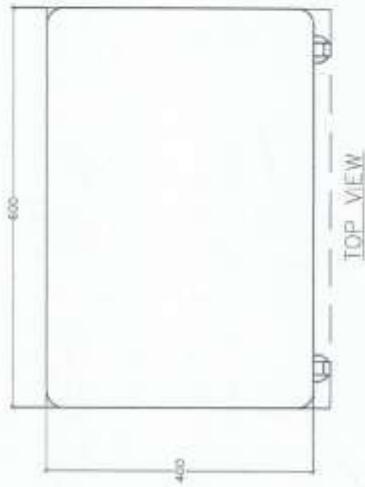

| | | | | | |
|--|---|---|---|---|---|
| <p>DEPED DIVISION OFFICE MARIKINA CITY</p> | <p>DESIGNED BY: <i>[Signature]</i> CHECKED BY: <i>[Signature]</i> DATE: 08/15/2021</p> | <p>PROJECT NO. 1</p> | <p>PROJECT TITLE: LEARNER'S TABLE (WOOD & STEEL)</p> | <p>DATE: 08/15/2021</p> | |
| | <p>APPROVED BY: <i>[Signature]</i> TITLE: ARCHITECT/PROJECT MANAGER OFFICE: MARIKINA CITY</p> | <p>APPROVED BY: <i>[Signature]</i> TITLE: ARCHITECT/PROJECT MANAGER OFFICE: MARIKINA CITY</p> | <p>APPROVED BY: <i>[Signature]</i> TITLE: ARCHITECT/PROJECT MANAGER OFFICE: MARIKINA CITY</p> | <p>APPROVED BY: <i>[Signature]</i> TITLE: ARCHITECT/PROJECT MANAGER OFFICE: MARIKINA CITY</p> | <p>APPROVED BY: <i>[Signature]</i> TITLE: ARCHITECT/PROJECT MANAGER OFFICE: MARIKINA CITY</p> |
| | <p>DEPED DIVISION OFFICE - MARIKINA CITY</p> | <p>DEPED DIVISION OFFICE - MARIKINA CITY</p> | <p>DEPED DIVISION OFFICE - MARIKINA CITY</p> | <p>DEPED DIVISION OFFICE - MARIKINA CITY</p> | <p>DEPED DIVISION OFFICE - MARIKINA CITY</p> |

DEPED SECONDARY SINGLE LEARNER'S TABLE



TOP VIEW

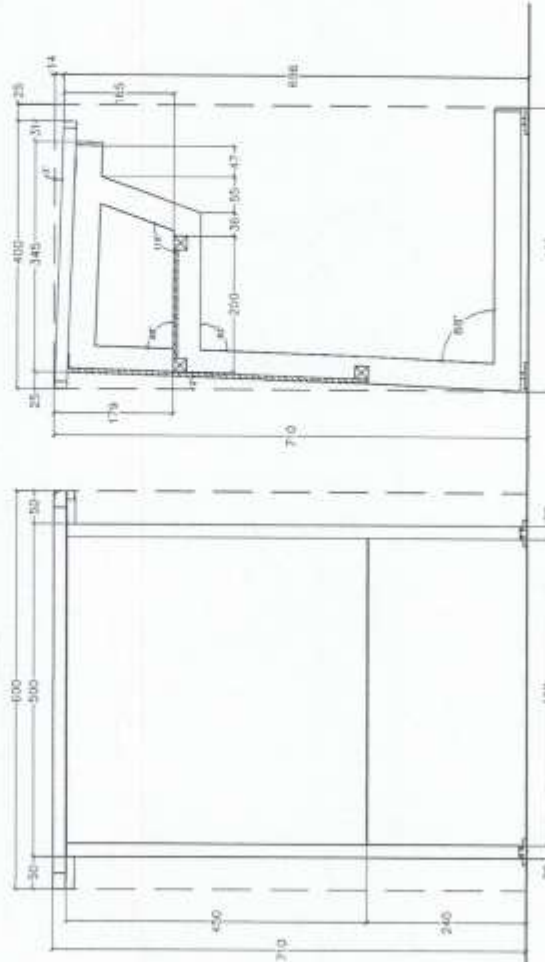

FRONT VIEW

SIDE SECTION VIEW

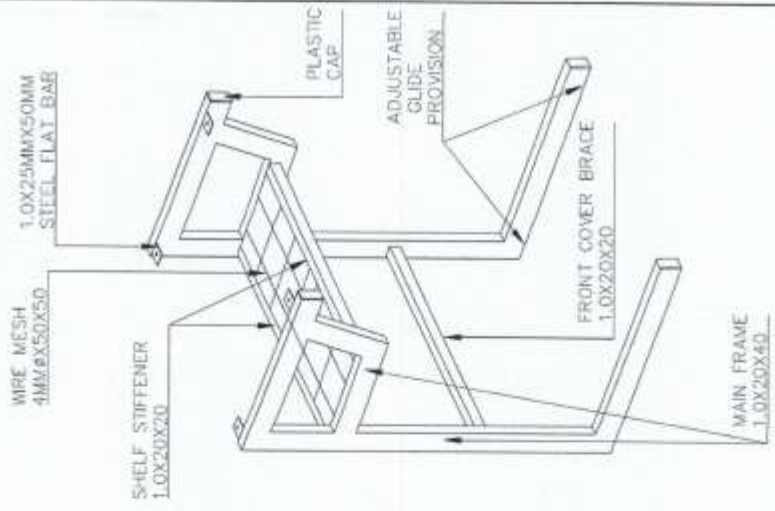

TABLE FRAMING PERSPECTIVE VIEW

| | | | | | | |
|--|--|-------------------------|--|-------------------------|---------------------------------|-------------------|
| <p>DEPED DIVISION OFFICE - MARIKINA CITY MARIKINA CITY</p> | <p>DESIGNER: <i>[Signature]</i> PROJECT: LEARNER'S TABLE</p> | <p>REVISIONS:</p> | <p>APPROVED BY: <i>[Signature]</i> PROJECT MANAGER</p> | <p>DATE: 01/15/2023</p> | <p>PROJECT NO.: 2023-01-001</p> | <p>REV. NO. 3</p> |
| | <p>PROJECT TITLE: LEARNER'S TABLE (WOOD & STEEL)</p> | <p>DATE: 01/15/2023</p> | <p>PROJECT NO.: 2023-01-001</p> | <p>REV. NO. 3</p> | <p>REV. NO. 3</p> | <p>REV. NO. 3</p> |

| 1 TECHNICAL SPECIFICATIONS OF TEACHER'S CHAIR | | |
|---|-----------------------------|---|
| MARK | COMPONENTS | SPECIFICATIONS |
| A | SEAT | BLOW MOULDED PLASTIC HIGH-DENSITY POLYETHYLENE (HDPE) |
| B | BACK | BLOW MOULDED PLASTIC HIGH-DENSITY POLYETHYLENE (HDPE) |
| C | BACK SUPPORT | Ø1 PIPE TUBE 1.0MMX22MM |
| D | SEAT SUPPORT | Ø1 PIPE TUBE 1.0MMX18MM |
| E | BACK LEG | Ø1 PIPE TUBE 1.0MMX22MM |
| F | FRONT LEG | Ø1 PIPE TUBE 1.0MMX22MM |
| G | LOWER SEAT SUPPORT SQ. TUBE | 1.0MMX18MMX18MM |
| I | COVER CAP | PLASTIC GLIDE |
| | | BACK HOPE TO STEEL → SELF TAPPING SCREW |
| | | SEAT HOPE TO STEEL → 3MM THK 25MMX30MM FLAT BAR, M6X2 BOLT |
| SCHEDULE OF FINISHES | | |
| BLOW MOULDED | | HIGH-DENSITY POLYETHYLENE (HDPE) PLASTIC |
| METAL/STEEL TUBULAR | | 60-80 MICRON POWDER COAT FINISH FLAT BLACK FINISH |
| HOPE COLOR | | REFER TO COLOR CODE PANTONE 4885C OR COLOR HEX: #4A0786 / R48-205, 167, 136 / CMYK: 0%, 100%, 34%, 20% |
| DIMENSIONS OF TEACHER'S CHAIR (mm) | | |
| COMPONENTS | DIMENSIONS | |
| SEAT HEIGHT | | 412 |
| SEAT DEPTH | | 360 |
| SEAT WIDTH | | 370 |
| BACK HEIGHT | | 800 |
| BACK WIDTH | | 410 |

ISOMETRIC VIEW OF TEACHER'S CHAIR
SCALE: 1:1

| | | | |
|---|--|--|---|
| <p>DepEd DIVISION OFFICE - MARIKINA CITY</p> | <p>DESIGNED BY: <i>[Signature]</i></p> <p>DATE: 10/20/2023</p> <p>BY: <i>[Signature]</i></p> <p>NO. 1 - BISHOP FELIX BARRA</p> | <p>APPROVED BY: <i>[Signature]</i></p> <p>DATE: 10/20/2023</p> <p>BY: <i>[Signature]</i></p> <p>NO. 1 - BISHOP FELIX BARRA</p> | <p>PROJECT TITLE: TEACHER'S CHAIR (HDPE & STEEL)</p> <p>DATE SUBMITTED: 10/20/2023</p> |
| <p>DEPED MARIKINA CITY</p> | <p>MARIKINA CITY</p> | <p>MARIKINA CITY</p> | <p>FILE NO. 1</p> <p>2</p> |

DEPED TEACHER'S CHAIR

DEPED LOGO SPECIFICATIONS FOR ALL LEARNER AND TEACHER'S CHAIR

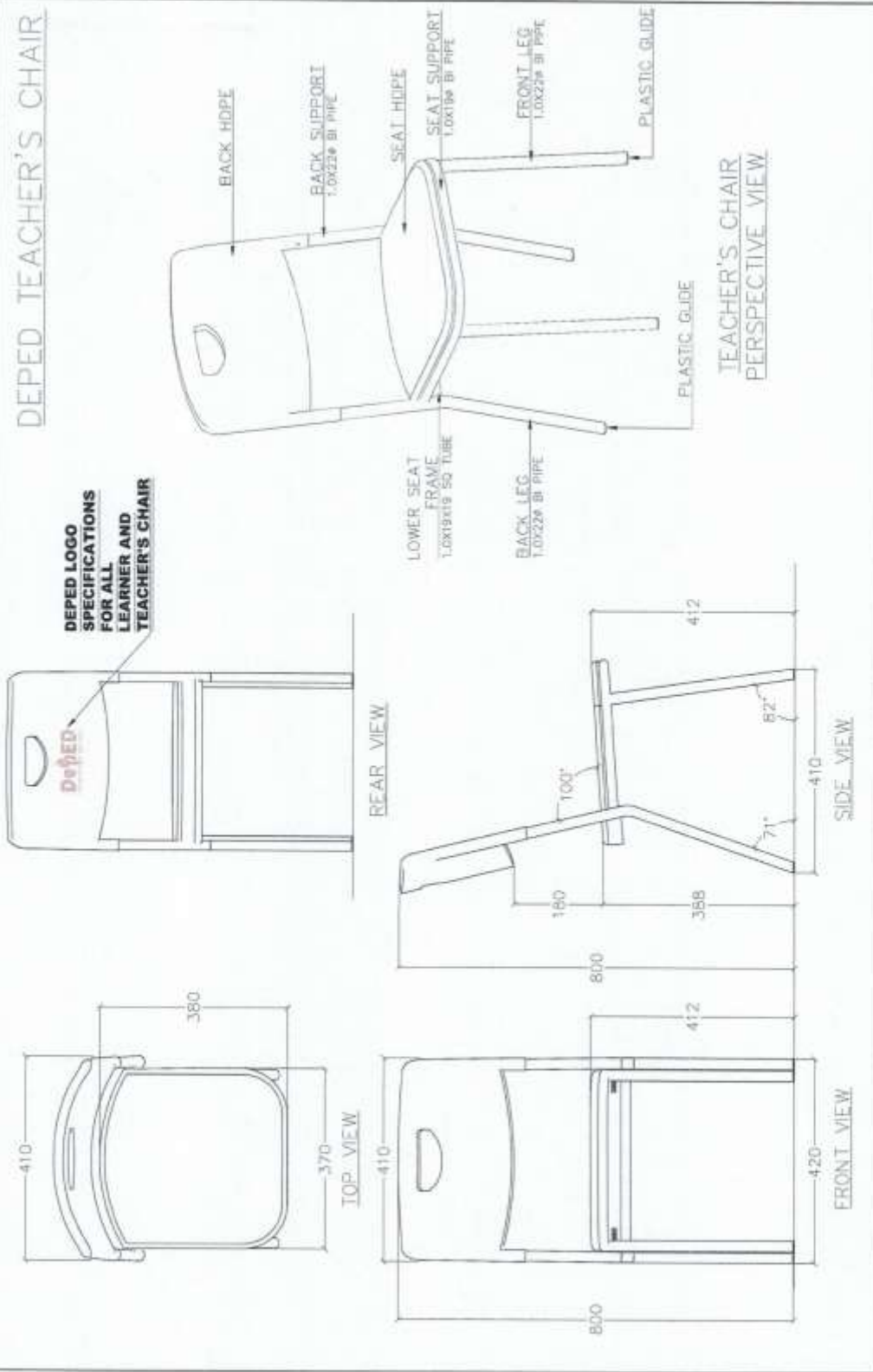

| | | | | | | | | |
|---|---|--|--|--|--|----------------------------|----------------------------|---------------------|
|  DEPED DEPARTMENT OF EDUCATION DIVISION OFFICE - CALABARZON CALABARZON AREA OFFICE | REVISIONS NO. 1 DATE: 08/20/2021 | DESIGNER J. T. TORRES DATE: 08/20/2021 | CHECKER J. T. TORRES DATE: 08/20/2021 | APPROVER J. T. TORRES DATE: 08/20/2021 | PROJECT TITLE TEACHER'S CHAIR (HDPE & STEEL) | SHEET NUMBER 2 OF 201 | SHEET SIZE 297 x 420 mm | SHEET NO. 2 2 |
| | DEPED LOGO SPECIFICATIONS FOR ALL LEARNER AND TEACHER'S CHAIR | | PROJECT TITLE TEACHER'S CHAIR (HDPE & STEEL) | | SHEET NUMBER 2 OF 201 | SHEET SIZE 297 x 420 mm | SHEET NO. 2 2 | |

| 1 | | TECHNICAL SPECIFICATIONS OF TEACHER'S TABLE | |
|-----------------------|---|--|--|
| MARK | COMPONENTS | SPECIFICATIONS | |
| A | TABLE TOP | 18MM THK TOP BOARD ROUND CORNERS (1 SIDE 1.0MM THK HIGH PRESSURE LAMINATE / 1 SIDE VARNISH FINISHES ON MARINE PLYWOOD) | |
| B | EDGING | 2.0MM THICK PVC EDGING | |
| C | SIDE COVER | 0.6MM THICK COLD ROLL STEEL IN POWDER COATED FINISHES | |
| D | FRONT COVER | 0.6MM THICK COLD ROLL STEEL IN POWDER COATED FINISHES WITH PUNCH HOLE DESIGN | |
| E | PULL OUT DRAWER | DRAWER FACE : 1.0MM THK HIGH PRESSURE LAMINATE / 1 SIDE VARNISH FINISHES ON 18MM THICK MARINE PLYWOOD DRAWER BOX : 0.6MM THK COLD ROLL STEEL IN POWDER COATED FINISHES DRAWER LOCK : 1 LOCK ONLY PER TABLE, 400MM LONG RAIL GUIDE | |
| F | MAIN FRAME | 1.0MM THK X 30MM X 30MM STEEL TUBULAR | |
| G | SECONDARY FRAME | 1.0MM THK X 30MM X 30MM STEEL TUBULAR | |
| | ADJUSTABLE LEVELER | ØMMØ THREAD WITH 2ØMMØ PLASTIC BASE | |
| | CONNECTOR | METAL FRAME BAR AND SCREW | |
| | CONNECTION | WOOD TO STEEL : SCREW / WOOD SCREW STEEL TO STEEL : FULL WELDING FOR TUBULAR TO FLAT BAR / CONNECTION STEEL TO STEEL : WOOD SCREW / BOLT AND NUT FOR STEEL TUBULAR KID DESIGN IS FOR BIDDER TO PROPOSE | |
| 2a | | | |
| SCHEDULE OF FINISHES | | | |
| TOP BOARD | 18MM THK TOP BOARD ROUND CORNERS (1 SIDE 1.0MM THK HIGH PRESSURE LAMINATE / 1 SIDE VARNISH FINISHES ON MARINE PLYWOOD) | | |
| EDGING | 2.0MM THICK PVC EDGING | | |
| SIDE/FRONT COVER | 60-60 MICRON POWDER COAT FINISH FLAT BLACK FINISH | | |
| METAL/STEEL TUBULAR | 60-60 MICRON POWDER COAT FINISH FLAT BLACK FINISH | | |
| LAMINATE COLOR | PANTONE 728C OR COLOR HEX #9A748E / RGB 156, 124, 89 / CMYK 0%, 33%, 63%, 27% WITH WOOD GRAIN (SERRANO BEECH OR EQUIVALENT) | | |
| 2b | | | |
| EDGING -- APPLICATION | | | |
| 1 | GLUE APPLICATION ON EDGE OF TABLE TOP | | |
| 2 | APPLY PVC EDGING AND TRIM AND CLEAN | | |

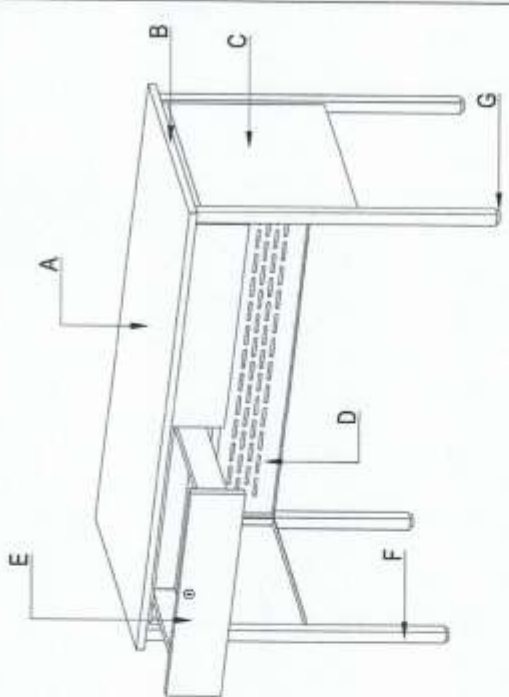

ISOMETRIC VIEW OF TEACHER'S TABLE

3

DIMENSIONS OF TEACHER'S TABLE (mm)

| MARK | COMPONENTS | DIMENSIONS | REMARKS |
|------|--------------------|------------|--|
| a | TABLE HEIGHT | 750 | ALL DIMENSION SHALL BE SUBJECTED TO A MAXIMUM TOLERANCE OF PLUS 10MM |
| b | TABLE LENGTH | 1200 | |
| c | TABLE WIDTH | 600 | |
| d | SIDING/FRONT COVER | 380 | |

| | | | |
|---|--|--|--|
|  | <p>TECHNICAL SPECIFICATIONS OF TEACHER'S TABLE</p> <p>18MM THK TOP BOARD ROUND CORNERS (1 SIDE 1.0MM THK HIGH PRESSURE LAMINATE / 1 SIDE VARNISH FINISHES ON MARINE PLYWOOD)</p> | <p>TECHNICAL SPECIFICATIONS OF TEACHER'S TABLE</p> <p>18MM THK TOP BOARD ROUND CORNERS (1 SIDE 1.0MM THK HIGH PRESSURE LAMINATE / 1 SIDE VARNISH FINISHES ON MARINE PLYWOOD)</p> | <p>TECHNICAL SPECIFICATIONS OF TEACHER'S TABLE</p> <p>18MM THK TOP BOARD ROUND CORNERS (1 SIDE 1.0MM THK HIGH PRESSURE LAMINATE / 1 SIDE VARNISH FINISHES ON MARINE PLYWOOD)</p> |
| <p>1</p> | <p>2</p> | <p>3</p> | <p>4</p> |

TEACHER'S TABLE

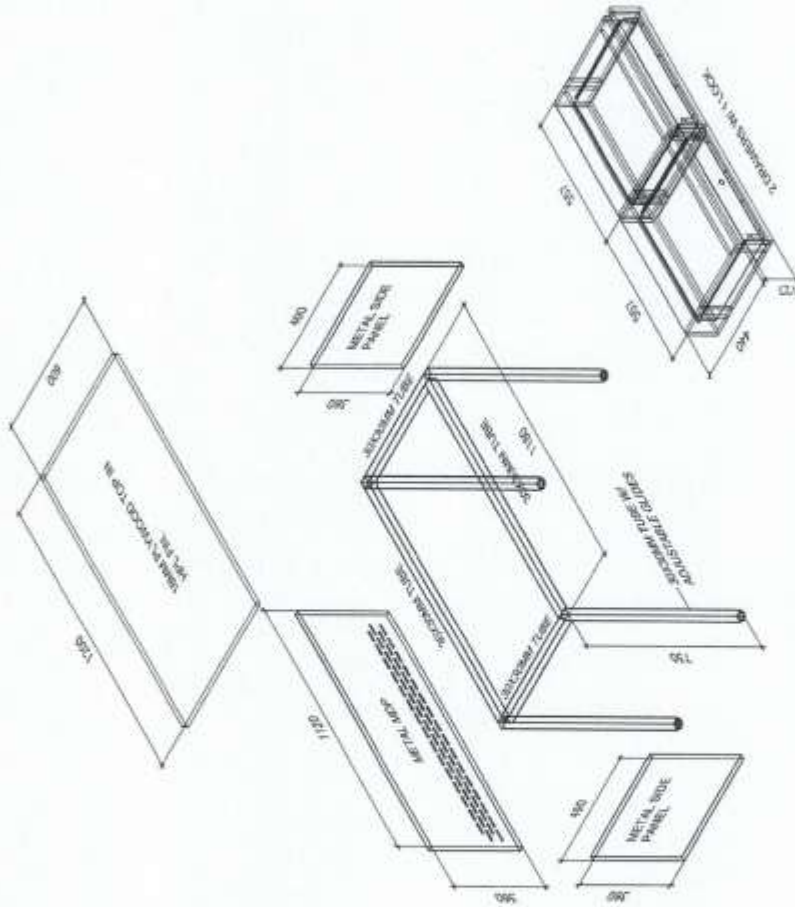

EXPLODED VIEW

| | | | | | | |
|---|---|--|--|---|---------------------------|--------------------------|
|  |  J.P. SANTOS PROJECT MANAGER |  MEL JAMBELLE PROJECT MANAGER |  BUREAU OF ARCHITECTURE CIVIL ENGINEERING DIVISION | PROJECT TITLE: TEACHER'S TABLE (WOOD & STEEL) | SHEET NUMBER: 3 | SHEET TOTAL: 6 |
| | | | | | | |

METAL FRAMING DETAIL

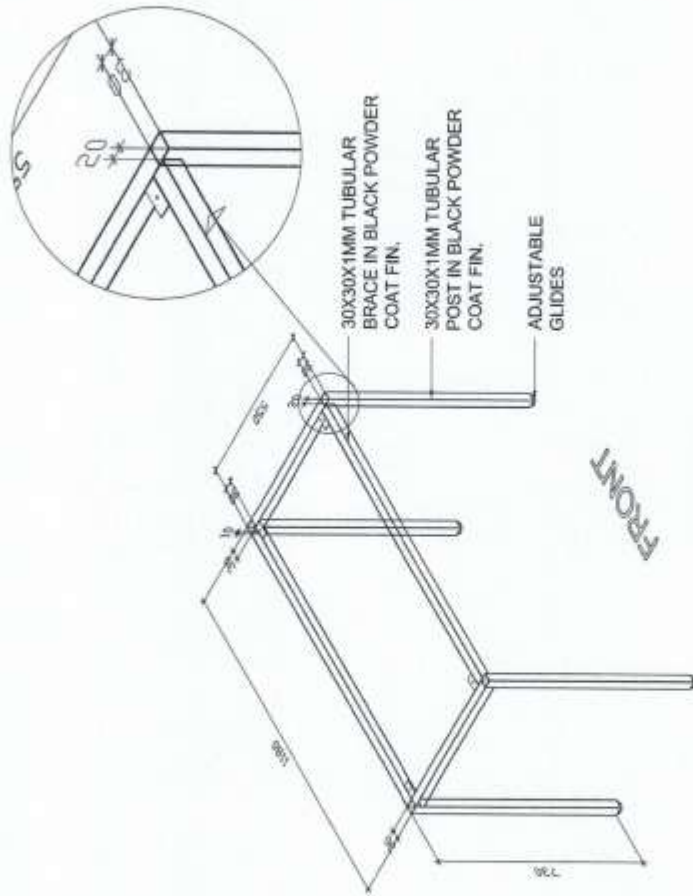

FRONT
PERSPECTIVE

| | | | | | | |
|---|--|--|--|---|--|--|
|  <p>Delfed DISTRIBUTION</p> | <p>DESIGNER: <i>[Signature]</i> AT: <i>[Signature]</i></p> | <p>MANUFACTURER: <i>[Signature]</i> DISTRIBUTION: <i>[Signature]</i></p> | <p>PROJECT: <i>[Signature]</i> DATE: 10/2011</p> | <p>PROJECT TITLE: TEACHER'S TABLE (WOOD & STEEL)</p> | <p>SHEET NUMBER: METAL FRAMING PERSPECTIVE</p> | <p>SHEET NO: 4 6</p> |
|---|--|--|--|---|--|--|

METAL CENTRAL DRAWER DETAIL



PLAN



FRONT ELEV.

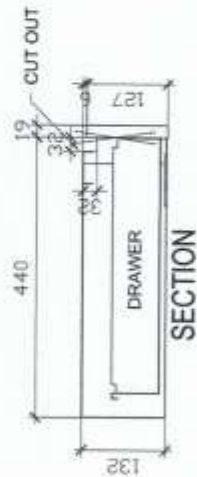

SECTION

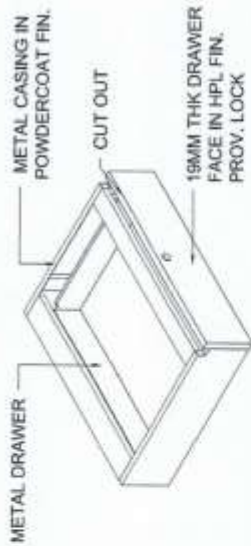

PERSPECTIVE

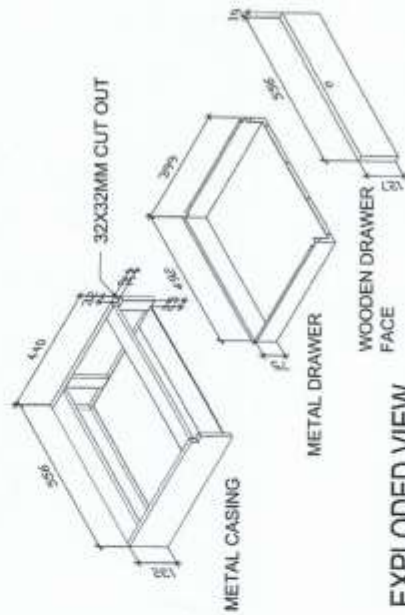

EXPLODED VIEW

| | | | | | | | |
|---|---|--|--|---|--|--|---------------------|
|  | NUMBER OF STUDENTS Defped INSTITUTIONAL TRAINING INSTITUTIONAL TRAINING | NUMBER OF  DR. NIRMALA S. RAO HEAD | REGULATORY OFFICIAL  DR. NIRMALA S. RAO DRP - EDUCATION TRUSTS BOARD | APPROVED BY  UNIVERSITY OF ANDHRA PRADH | PROJECT TITLE TEACHER'S TABLE (WOOD & STEEL) | BEST DRAWER METAL DRAWER DETAIL METAL SOLUTION APPROVED VIEW PERSPECTIVE | SHEET NO. 5 6 |
| | DATE OF ISSUE 07/08/2021 | PROJECT NO. 07/2021 | DRAWN BY 07/2021 | CHECKED BY 07/2021 | DATE OF ISSUE 07/2021 | PROJECT NO. 07/2021 | SHEET NO. 5 6 |

PERFORATED MDP & SIDE PANEL DETAIL

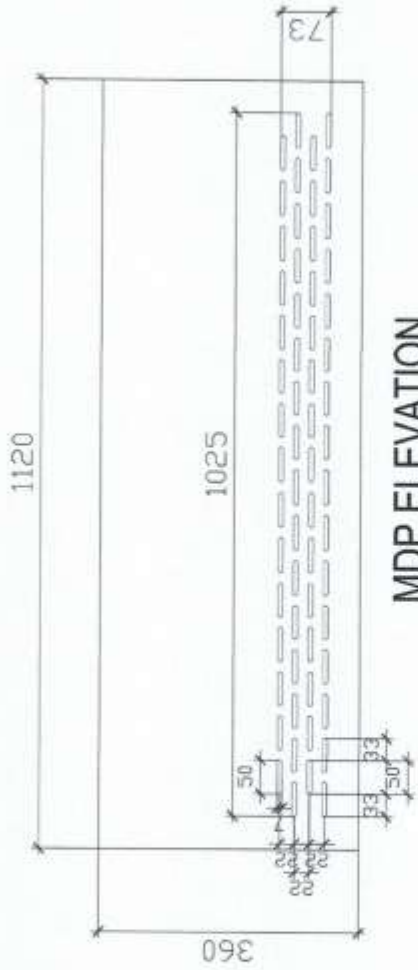

MDP ELEVATION

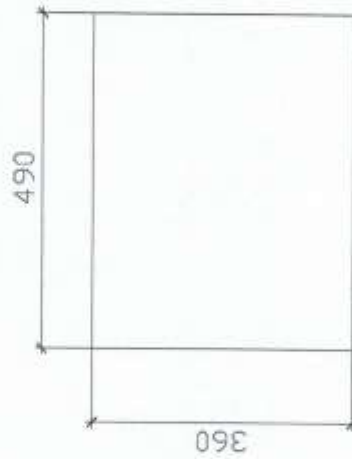

SIDE PANEL ELEVATION

| | | | | | | |
|--|--|--|--|--|---|------------------------------|
|  <p>DEPED DIVISION OFFICE - MARIKINA CITY</p> | <p>DESIGNED BY: <i>[Signature]</i> ARCHITECT</p> | <p>RECORDING OFFICER: MARICELYN S. ALIBON OFF. - DESIGN ASSISTANT (DESIGN)</p> | <p>PROJECT NO. 1: MARICELYN S. ALIBON OFFICER FOR ASSISTANCE</p> | <p>PROJECT TITLE: TEACHER'S TABLE (WOOD & STEEL)</p> | <p>SET NUMBER: PERFORATED MDP & SIDE PANEL DETAIL</p> | <p>SHEET NO. 6 6</p> |
|--|--|--|--|--|---|------------------------------|

Section VIII. Checklist of Technical and Financial Documents

Notes on the Checklist of Technical and Financial Documents

The prescribed documents in the checklist are mandatory to be submitted in the Bid, but shall be subject to the following:

- a. GPPB Resolution No. 09-2020 on the efficient procurement measures during a State of Calamity or other similar issuances that shall allow the use of alternate documents in lieu of the mandated requirements; or
- b. Any subsequent GPPB issuances adjusting the documentary requirements after the effectivity of the adoption of the PBDs.

The BAC shall be checking the submitted documents of each Bidder against this checklist to ascertain if they are all present, using a non-discretionary “pass/fail” criterion pursuant to Section 30 of the 2016 revised IRR of RA No. 9184.

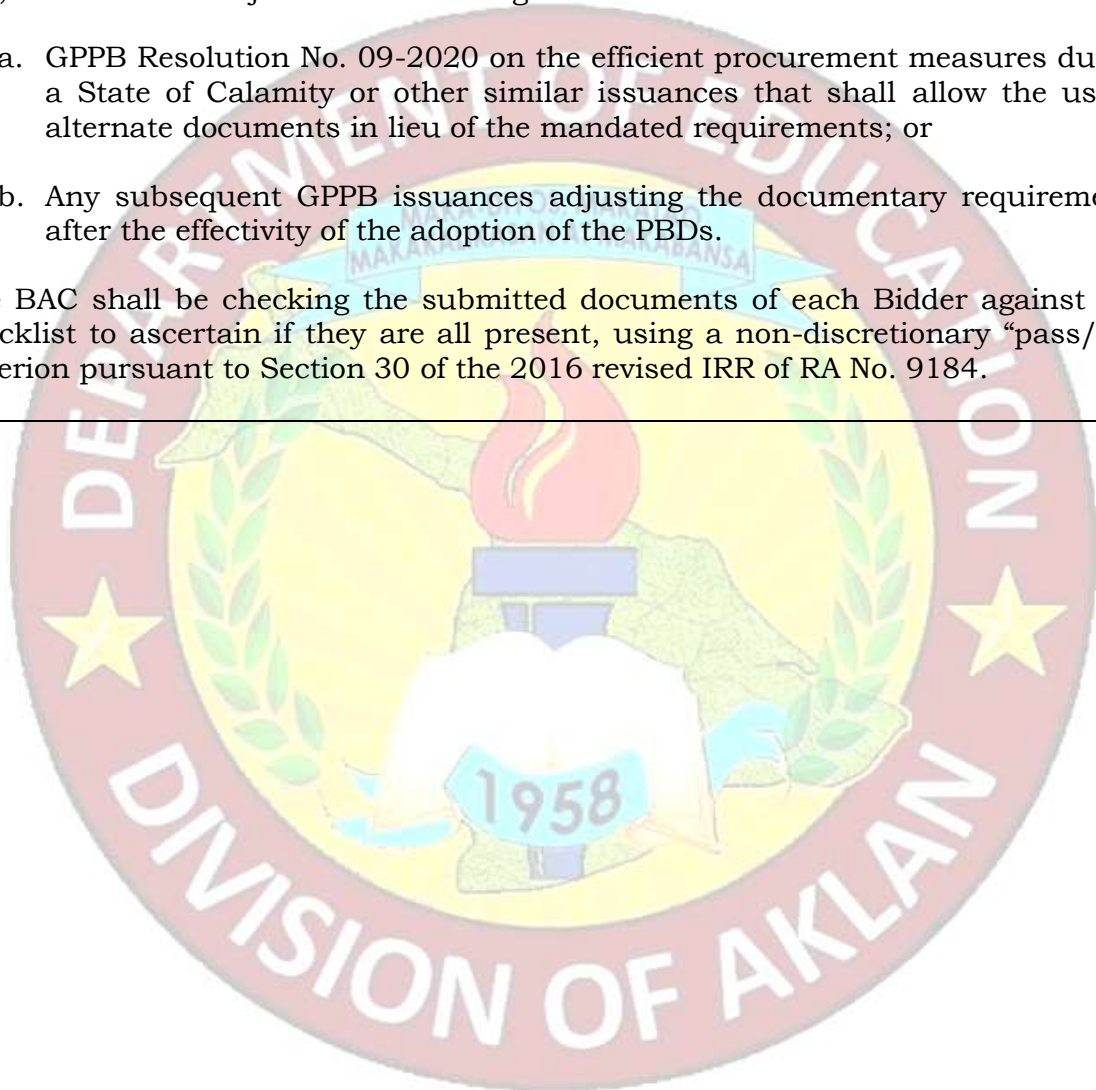

Checklist of Technical and Financial Documents

I. TECHNICAL COMPONENT ENVELOPE

Class "A" Documents

Legal Documents

- (a) Valid PhilGEPS Registration Certificate (Platinum Membership) (all pages);
or
- (b) Registration certificate from Securities and Exchange Commission (SEC), Department of Trade and Industry (DTI) for sole proprietorship, or Cooperative Development Authority (CDA) for cooperatives or its equivalent document,
and
- (c) Mayor's or Business permit issued by the city or municipality where the principal place of business of the prospective bidder is located, or the equivalent document for Exclusive Economic Zones or Areas;
and
- (d) Tax clearance per E.O. No. 398, s. 2005, as finally reviewed and approved by the Bureau of Internal Revenue (BIR).

Technical Documents

- (f) Statement of the prospective bidder of all its ongoing government and private contracts, including contracts awarded but not yet started, if any, whether similar or not similar in nature and complexity to the contract to be bid; **and**
- (g) Statement of the bidder's Single Largest Completed Contract (SLCC) similar to the contract to be bid, except under conditions provided for in Sections 23.4.1.3 and 23.4.2.4 of the 2016 revised IRR of RA No. 9184, within the relevant period as provided in the Bidding Documents; **and**
- (h) Original copy of Bid Security. If in the form of a Surety Bond, submit also a certification issued by the Insurance Commission;
or
Original copy of Notarized Bid Securing Declaration; **and**
- (i) Conformity with the Technical Specifications, which may include production/delivery schedule, manpower requirements, and/or after-sales/parts, if applicable; **and**
- (j) Original duly signed Omnibus Sworn Statement (OSS); **and** if applicable, Original Notarized Secretary's Certificate in case of a corporation, partnership, or cooperative; or Original Special Power of Attorney of all members of the joint venture giving full power and authority to its officer to sign the OSS and do acts to represent the Bidder.

Financial Documents

- (k) The Supplier's audited financial statements, showing, among others, the Supplier's total and current assets and liabilities, stamped "received" by the BIR or its duly accredited and authorized institutions, for the preceding calendar year which should not be earlier than two (2) years from the date of bid submission; **and**
- (l) The prospective bidder's computation of Net Financial Contracting Capacity (NFCC);
or
A committed Line of Credit from a Universal or Commercial Bank in lieu of its NFCC computation.

Class "B" Documents

- (m) If applicable, a duly signed joint venture agreement (JVA) in case the joint venture is already in existence;
or
duly notarized statements from all the potential joint venture partners stating that they will enter into and abide by the provisions of the JVA in the instance that the bid is successful.

Other documentary requirements under RA No. 9184 (as applicable)

- (n) *[For foreign bidders claiming by reason of their country's extension of reciprocal rights to Filipinos]* Certification from the relevant government office of their country stating that Filipinos are allowed to participate in government procurement activities for the same item or product.
- (o) Certification from the DTI if the Bidder claims preference as a Domestic Bidder or Domestic Entity.

II. FINANCIAL COMPONENT ENVELOPE

- (a) Original of duly signed and accomplished Financial Bid Form;
and
- (b) Original of duly signed and accomplished Price Schedule(s).

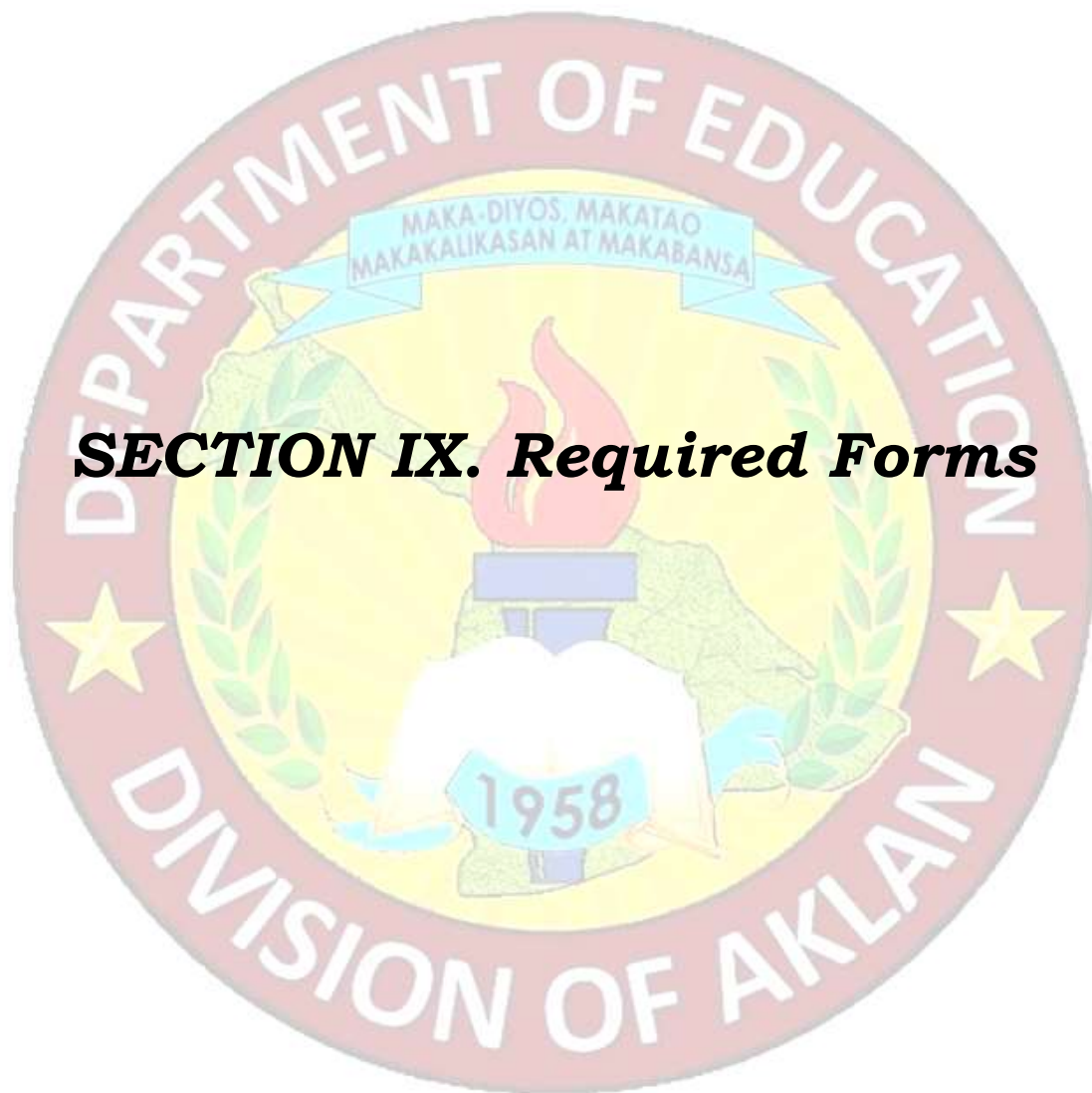

Bid Form for the Procurement of Goods
[shall be submitted with the Bid]

BID FORM

Date : _____

Project Identification No. : _____

To: [name and address of Procuring Entity]

Having examined the Philippine Bidding Documents (PBDs) including the Supplemental or Bid Bulletin Numbers [insert numbers], the receipt of which is hereby duly acknowledged, we, the undersigned, offer to [supply/deliver/perform] [description of the Goods] in conformity with the said PBDs for the sum of [total Bid amount in words and figures] or the total calculated bid price, as evaluated and corrected for computational errors, and other bid modifications in accordance with the Price Schedules attached herewith and made part of this Bid. The total bid price includes the cost of all taxes, such as, but not limited to: [specify the applicable taxes, e.g. (i) value added tax (VAT), (ii) income tax, (iii) local taxes, and (iv) other fiscal levies and duties], which are itemized herein or in the Price Schedules,

If our Bid is accepted, we undertake:

- a. to deliver the goods in accordance with the delivery schedule specified in the Schedule of Requirements of the Philippine Bidding Documents (PBDs);
- b. to provide a performance security in the form, amounts, and within the times prescribed in the PBDs;
- c. to abide by the Bid Validity Period specified in the PBDs and it shall remain binding upon us at any time before the expiration of that period.

[Insert this paragraph if Foreign-Assisted Project with the Development Partner:

Commissions or gratuities, if any, paid or to be paid by us to agents relating to this Bid, and to contract execution if we are awarded the contract, are listed below:

| Name of agent | Amount | Purpose of Commission or gratuity |
|---------------|--------|-----------------------------------|
| _____ | _____ | _____ |
| _____ | _____ | _____ |
| _____ | _____ | _____ |

(if none, state "None"]

Until a formal Contract is prepared and executed, this Bid, together with your written acceptance thereof and your Notice of Award, shall be binding upon us.

We understand that you are not bound to accept the Lowest Calculated Bid or any Bid you may receive.

We certify/confirm that we comply with the eligibility requirements pursuant to the PBDs.

The undersigned is authorized to submit the bid on behalf of [name of the bidder] as evidenced by the attached [state the written authority].

We acknowledge that failure to sign each and every page of this Bid Form, including the attached Schedule of Prices, shall be a ground for the rejection of our bid.

Name: _____

Legal capacity: _____

Signature: _____

Duly authorized to sign the Bid for and behalf of: _____

Date: _____

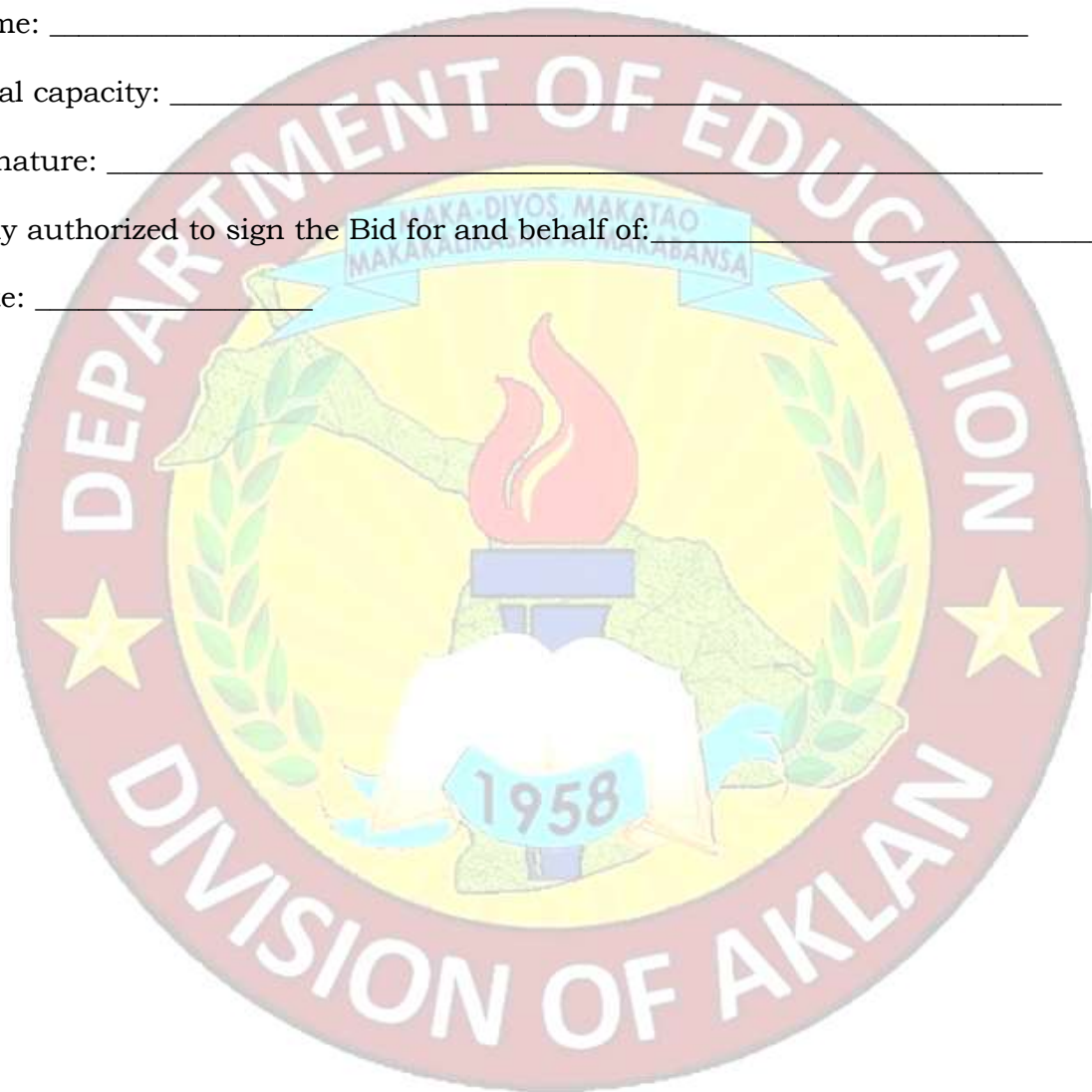

Price Schedule for Goods Offered from Within the Philippines

[shall be submitted with the Bid if bidder is offering goods from within the Philippines]

For Goods Offered from Within the Philippines

Name of Bidder _____ Project ID No. _____ Page ___ of ___

| 1 | 2 | 3 | 4 | 5 | 6 | 7 | 8 | 9 | 10 |
|------|-------------|-------------------|----------|-------------------------|---|--|---|--------------------------------------|---|
| Item | Description | Country of Origin | Quantity | Unit Price EXW per item | Transportation and all other costs incidental to delivery, per item | Sales and other taxes payable if Contract is awarded, per item | Cost of Incident al Services , if applica ble, per item | Total Price, per unit (col 5+6+7+8) | Total Price delivere d Final Destina tion (col 9) x (col 4) |
| | | | | | | | | | |

Name: _____

Legal Capacity: _____

Signature: _____

Duly authorized to sign the Bid for and behalf of: _____

Statement of Single Largest Completed Contract which is similar in nature

Business Name : _____

Business Address : _____

| Name of Contract | Date of Contract | Kind of Goods | Amount of Contract | Date of Delivery | End User's Acceptance or Official Receipt(s) Issued for the Contract |
|------------------|------------------|---------------|--------------------|------------------|--|
| | | | | | |
| | | | | | |
| | | | | | |

Submitted by : _____
(Printed Name and Signature)

Designation : _____

Date : _____

Instructions: a) State the single largest completed contract (government or private) within three (3) years prior to opening of bids

**List of all Ongoing Government & Private Contracts including
Contracts awarded but not yet started**

Business Name : _____

Business Address : _____

| Name of Contract | Date of Contract | Kinds of Goods | Amount of Contract | Value of Outstanding Contract | Date of Delivery |
|------------------|------------------|----------------|--------------------|-------------------------------|------------------|
| Government | | | | | |
| | | | | | |
| | | | | | |
| Private | | | | | |
| | | | | | |
| | | | | | |
| | | | | | |

Submitted by : _____
(Printed Name and Signature)

Designation : _____

Date : _____

Instructions: a) State all ongoing contracts including those awarded but not yet started (government and private contracts which may be similar or not similar to the project being bid). b) If there is no on-going contract including awarded but not yet started as of the aforementioned period, state none or equivalent term. c) The total amount of the on-going and awarded but not yet started contracts should be consistent with those used in the Net Financial Contracting Capacity (NFCC).

Bid Securing Declaration Form

[shall be submitted with the Bid if bidder opts to provide this form of bid security]

REPUBLIC OF THE PHILIPPINES)
CITY OF _____) S.S.

BID SECURING DECLARATION **Project Identification No.: [Insert number]**

To: [Insert name and address of the Procuring Entity]

I/We, the undersigned, declare that:

1. I/We understand that, according to your conditions, bids must be supported by a Bid Security which may be in the form of a Bid Securing Declaration.
2. I/We accept that: (a) I/we will be automatically disqualified from bidding for any procurement contract with any procuring entity for a period of two (2) years upon receipt of your Blacklisting Order; and, (b) I/we will pay the applicable fine provided under Section 6 of the Guidelines on the Use of Bid Securing Declaration, within fifteen (15) days from receipt of the written demand by the procuring entity for the commission of acts resulting to the enforcement of the bid securing declaration under Sections 23.1(b), 34.2, 40.1 and 69.1, except 69.1(f), of the IRR of RA No. 9184; without prejudice to other legal action the government may undertake.
3. I/We understand that this Bid Securing Declaration shall cease to be valid on the following circumstances:
 - a. Upon expiration of the bid validity period, or any extension thereof pursuant to your request;
 - b. I am/we are declared ineligible or post-disqualified upon receipt of your notice to such effect, and (i) I/we failed to timely file a request for reconsideration or (ii) I/we filed a waiver to avail of said right; and
 - c. I am/we are declared the bidder with the Lowest Calculated Responsive Bid, and I/we have furnished the performance security and signed the Contract.

IN WITNESS WHEREOF, I/We have hereunto set my/our hand/s this ____ day of [month] [year] at [place of execution].

[Insert NAME OF BIDDER OR ITS AUTHORIZED REPRESENTATIVE]

[Insert signatory's legal capacity]

Affiant

[Jurat]

[Format shall be based on the latest Rules on Notarial Practice]

NFCC COMPUTATION FORMAT

a. Summary of the Applicant Supplier's/Distributor's/Manufacturer's assets and liabilities on the basis of the attached income tax return and audited financial statement, stamped "RECEIVED" by the Bureau of Internal Revenue or BIR authorized collecting agent, for the immediately preceding year and a certified copy of Schedule of Fixed Assets particularly the list of construction equipment.

| | | Year 20__ |
|---|---------------------------|-----------|
| A | Total Assets | |
| B | Current Assets | |
| C | Total Liabilities | |
| D | Current Liabilities | |
| E | Net Worth (A-C) | |
| F | Net Working Capital (B-D) | |

b. The Net Financial Contracting Capacity (NFCC) based on the above data is computed as follows:

NFCC = K (current asset – current liabilities) minus value of all outstanding works under ongoing contracts including awarded contracts yet to be started

NFCC = P _____

K = 15

Herewith attached are certified true copies of the income tax return and audited financial statement: stamped "RECEIVED" by the BIR or BIR authorized collecting agent for the immediately preceding year.

Submitted by:

 Name of Supplier/Distributor/Manufacturer
 Signature of Authorized Representative

Date : _____

Note: If partnership or Joint Venture, each partner or member firm of Joint Venture shall submit the above requirements

Omnibus Sworn Statement (Revised)

[shall be submitted with the Bid]

REPUBLIC OF THE PHILIPPINES)
CITY/MUNICIPALITY OF _____) S.S.

AFFIDAVIT

I, [Name of Affiant], of legal age, [Civil Status], [Nationality], and residing at [Address of Affiant],
after having been duly sworn in accordance with law, do hereby depose and state that:

1. [Select one, delete the other:]

[If a sole proprietorship:] I am the sole proprietor or authorized representative of [Name of Bidder] with office address at [address of Bidder];

[If a partnership, corporation, cooperative, or joint venture:] I am the duly authorized and designated representative of [Name of Bidder] with office address at [address of Bidder];

2. [Select one, delete the other:]

[If a sole proprietorship:] As the owner and sole proprietor, or authorized representative of [Name of Bidder], I have full power and authority to do, execute and perform any and all acts necessary to participate, submit the bid, and to sign and execute the ensuing contract for [Name of the Project] of the [Name of the Procuring Entity], as shown in the attached duly notarized Special Power of Attorney;

[If a partnership, corporation, cooperative, or joint venture:] I am granted full power and authority to do, execute and perform any and all acts necessary to participate, submit the bid, and to sign and execute the ensuing contract for [Name of the Project] of the [Name of the Procuring Entity], as shown in the attached [state title of attached document showing proof of authorization (e.g., duly notarized Secretary's Certificate, Board/Partnership Resolution, or Special Power of Attorney, whichever is applicable)];

3. [Name of Bidder] is not "blacklisted" or barred from bidding by the Government of the Philippines or any of its agencies, offices, corporations, or Local Government Units, foreign government/foreign or international financing institution whose blacklisting rules have been recognized by the Government Procurement Policy Board, **by itself or by relation, membership, association, affiliation, or controlling interest with another blacklisted person or entity as defined and provided for in the Uniform Guidelines on Blacklisting;**

4. Each of the documents submitted in satisfaction of the bidding requirements is an authentic copy of the original, complete, and all statements and information provided therein are true and correct;

5. [Name of Bidder] is authorizing the Head of the Procuring Entity or its duly authorized representative(s) to verify all the documents submitted;

6. [Select one, delete the rest:]

[If a sole proprietorship:] The owner or sole proprietor is not related to the Head of the Procuring Entity, members of the Bids and Awards Committee (BAC), the Technical Working Group, and the BAC Secretariat, the head of the Project Management Office or the end-user unit, and the project consultants by consanguinity or affinity up to the third civil degree;

[If a partnership or cooperative:] None of the officers and members of [Name of Bidder] is related to the Head of the Procuring Entity, members of the Bids and Awards Committee (BAC), the Technical Working Group, and the BAC Secretariat, the head of the Project Management Office or the end-user unit, and the project consultants by consanguinity or affinity up to the third civil degree;

[If a corporation or joint venture:] None of the officers, directors, and controlling stockholders of [Name of Bidder] is related to the Head of the Procuring Entity, members of the Bids and Awards Committee (BAC), the Technical Working Group, and the BAC Secretariat, the head of the Project Management Office or the end-user unit, and the project consultants by consanguinity or affinity up to the third civil degree;

7. [Name of Bidder] complies with existing labor laws and standards; and
8. [Name of Bidder] is aware of and has undertaken the responsibilities as a Bidder in compliance with the Philippine Bidding Documents, which includes:
 - a. Carefully examining all of the Bidding Documents;
 - b. Acknowledging all conditions, local or otherwise, affecting the implementation of the Contract;
 - c. Making an estimate of the facilities available and needed for the contract to be bid, if any; and
 - d. Inquiring or securing Supplemental/Bid Bulletin(s) issued for the [Name of the Project].
9. [Name of Bidder] did not give or pay directly or indirectly, any commission, amount, fee, or any form of consideration, pecuniary or otherwise, to any person or official, personnel or representative of the government in relation to any procurement project or activity.

10. In case advance payment was made or given, failure to perform or deliver any of the obligations and undertakings in the contract shall be sufficient grounds to constitute criminal liability for Swindling (Estafa) or the commission of fraud with unfaithfulness or abuse of confidence through misappropriating or converting any payment received by a person or entity under an obligation involving the duty to deliver certain goods or services, to the prejudice of the public and the government of the Philippines pursuant to Article 315 of Act No. 3815 s. 1930, as amended, or the Revised Penal Code.

IN WITNESS WHEREOF, I have hereunto set my hand this __ day of __, 20__ at _____, Philippines.

[Insert NAME OF BIDDER OR ITS AUTHORIZED REPRESENTATIVE]

[Insert signatory's legal capacity]

Affiant

[Jurat]

[Format shall be based on the latest Rules on Notarial Practice]

Performance Securing Declaration (Revised)

[if used as an alternative performance security but it is not required to be submitted with the Bid, as it shall be submitted within ten (10) days after receiving the Notice of Award]

REPUBLIC OF THE PHILIPPINES)
CITY OF _____) S.S.

PERFORMANCE SECURING DECLARATION

Invitation to Bid: [Insert Reference Number indicated in the Bidding Documents]
To: [Insert name and address of the Procuring Entity]

I/We, the undersigned, declare that:

1. I/We understand that, according to your conditions, to guarantee the faithful performance by the supplier/distributor/manufacturer/contractor/consultant of its obligations under the Contract, I/we shall submit a Performance Securing Declaration within a maximum period of ten (10) calendar days from the receipt of the Notice of Award prior to the signing of the Contract.

2. I/We accept that: I/we will be automatically disqualified from bidding for any procurement contract with any procuring entity for a period of one (1) year for the first offense, or two (2) years **for the second offense**, upon receipt of your Blacklisting Order if I/We have violated my/our obligations under the Contract;

3. I/We understand that this Performance Securing Declaration shall cease to be valid upon:

a. issuance by the Procuring Entity of the Certificate of Final Acceptance, subject to the following conditions:

- i. Procuring Entity has no claims filed against the contract awardee;
- ii. It has no claims for labor and materials filed against the contractor; and
- iii. Other terms of the contract; or

b. replacement by the winning bidder of the submitted PSD with a performance security in any of the prescribed forms under Section 39.2 of the 2016 revised IRR of RA No. 9184 as required by the end-user.

IN WITNESS WHEREOF, I/We have hereunto set my/our hand/s this ____ day of [month] [year] at [place of execution].

*[Insert NAME OF BIDDER OR ITS
AUTHORIZED REPRESENTATIVE]
[Insert signatory's legal capacity]
Affiant*

[Jurat]

[Format shall be based on the latest Rules on Notarial Practice]

